

machine numbers | B25A24Z | B27A24Z | B32A24Z | B36A24Z
| B25A74R | B27A74R | B25A76R | B27A76R

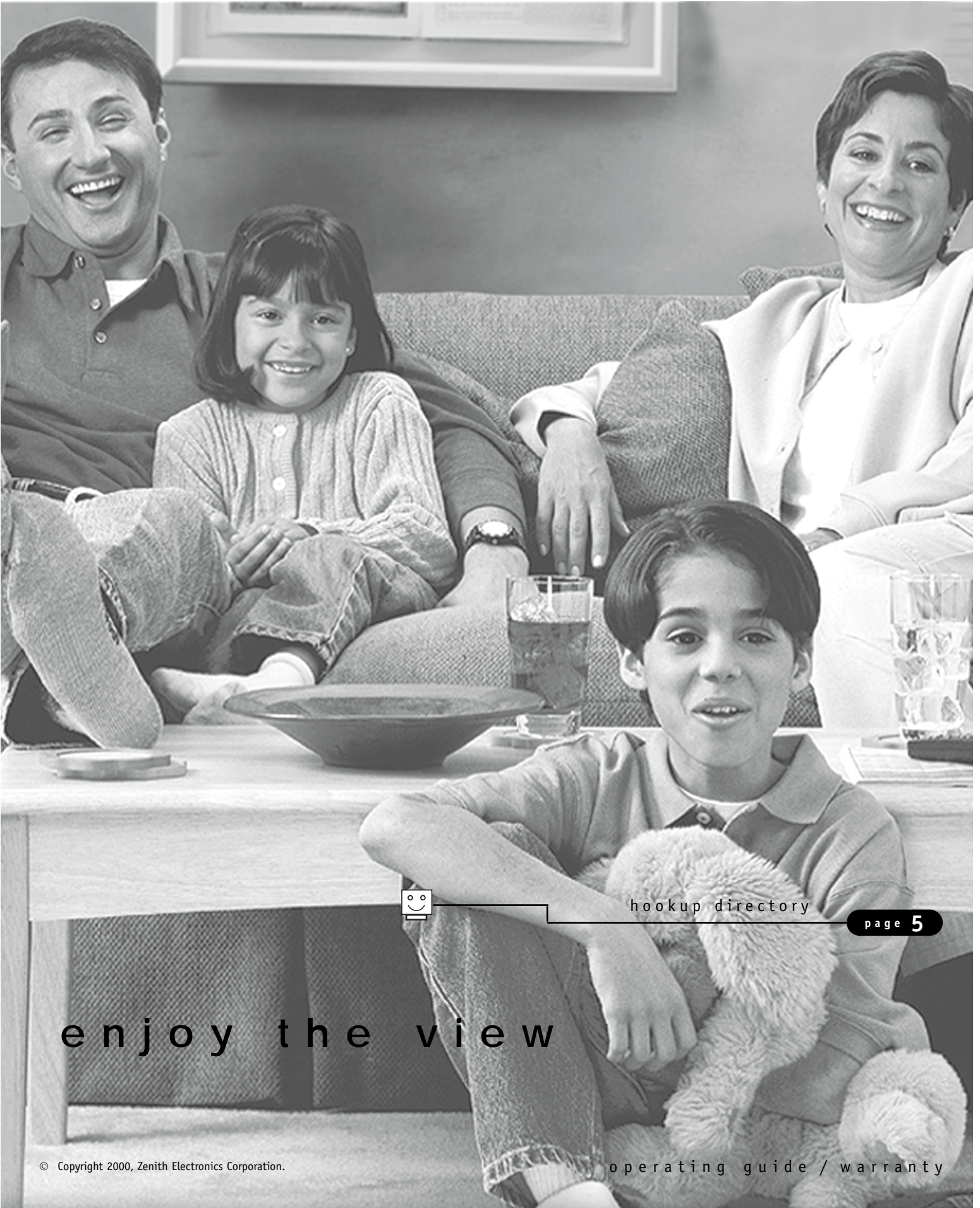

hookup directory

page 5

enjoy the view

**RECORD YOUR MODEL NUMBER
(Now, while you can see it)**

The model and serial number of your new TV are located on the back of the TV cabinet. For your future convenience, we suggest that you record these numbers here:

MODEL NO. _____

SERIAL NO. _____



WARNING
RISK OF ELECTRIC SHOCK
DO NOT OPEN



WARNING:

TO REDUCE THE RISK OF ELECTRIC SHOCK DO NOT REMOVE COVER (OR BACK). NO USER SERVICEABLE PARTS INSIDE. REFER SERVICING TO QUALIFIED SERVICE PERSONNEL.



The lightning flash with arrowhead symbol, within an equilateral triangle, is intended to alert the user to the presence of uninsulated "dangerous voltage" within the product's enclosure that may be of sufficient magnitude to constitute a risk of electric shock to persons.



The exclamation point within an equilateral triangle is intended to alert the user to the presence of important operating and maintenance (servicing) instructions in the literature accompanying the appliance.

WARNING:

TO PREVENT FIRE OR SHOCK HAZARDS, DO NOT EXPOSE THIS PRODUCT TO RAIN OR MOISTURE.

POWER CORD POLARIZATION:

CAUTION: TO PREVENT ELECTRIC SHOCK, MATCH WIDE BLADE OF PLUG TO WIDE SLOT, FULLY INSERT.

ATTENTION: POUR ÉVITER LES CHOCS ÉLECTRIQUES, INTRODUIRE LA LAME LA PLUS LARGE DE LA FICHE DANS LA BORNE CORRESPONDANTE DE LA PRISE ET POUSSER JUSQU'AU FOND.

NOTE TO CABLE/TV INSTALLER:

This reminder is provided to call the cable TV system installer's attention to Article 820-40 of the National Electric Code (U.S.A.). The code provides guidelines for proper grounding and, in particular, specifies that the cable ground shall be connected to the grounding system of the building, as close to the point of the cable entry as practical.

REGULATORY INFORMATION:

This equipment has been tested and found to comply with the limits for a Class B digital device, pursuant to Part 15 of the FCC Rules. These limits are designed to provide reasonable protection against harmful interference when the equipment is operated in a residential installation. This equipment generates, uses and can radiate radio frequency energy and, if not installed and used in accordance with the instruction manual, may cause harmful interference to radio communications. However, there is no guarantee that interference will not occur in a particular installation. If this equipment does cause harmful interference to radio or television reception, which can be determined by turning the equipment off and on, the user is encouraged to try to correct the interference by one or more of the following measures:

- Reorient or relocate the receiving antenna.
- Increase the separation between the equipment and receiver.
- Connect the equipment into an outlet on a circuit different from that to which the receiver is connected.
- Consult the dealer or an experienced radio/TV technician for help.

CAUTION:

Do not attempt to modify this product in any way without written authorization from Zenith Electronics Corporation. Unauthorized modification could void the user's authority to operate this product.

Entertainment Machine is a trademark of Zenith Electronics Corporation.

IMPORTANT SAFETY INSTRUCTIONS

Important safeguards for you and your new product

Your product has been manufactured and tested with your safety in mind. However, improper use can result in potential electrical shock or fire hazards. To avoid defeating the safeguards that have been built into your new product, please read and observe the following safety points when installing and using your new product, and save them for future reference.

Observing the simple precautions discussed in this booklet can help you get many years of enjoyment and safe operation that are built into your new product.

This product complies with all applicable U.S. Federal safety requirements, and those of the Canadian Standards Association.

1. Read Instructions

All the safety and operating instructions should be read before the product is operated.

2. Follow Instructions

All operating and use instructions should be followed.

3. Retain Instructions

The safety and operating instructions should be retained for future reference.

4. Heed Warnings

All warnings on the product and in the operating instructions should be adhered to.

5. Cleaning

Unplug this product from the wall outlet before cleaning. Do not use liquid cleaners or aerosol cleaners. Use a damp cloth for cleaning.

6. Water and Moisture

Do not use this product near water - for example, near a bath tub, wash bowl, kitchen sink, or laundry tub, in a wet basement, or near a swimming pool.

7. Accessories

Do not place this product on an unstable cart, stand, tripod, bracket, or table. The product may fall, causing serious injury to a child or adult, and serious damage to the product. Use only with a cart, stand, tripod, bracket, or table recommended by the manufacturer, or sold with the product. Any mounting of the product should follow the manufacturer's instructions, and should use a mounting accessory recommended by the manufacturer.

8. Transporting Product

A product and cart combination should be moved with care. Quick stops, excessive force, and uneven surfaces may cause the product and cart combination to overturn.



PORTABLE CART WARNING

9. Attachments

Do not use attachments not recommended by the product manufacturer as they may cause hazards.

10. Ventilation

Slots and openings in the cabinet are provided for ventilation and to ensure reliable operation of the product and to protect it from overheating, and these openings must not be blocked or covered. The openings should never be blocked by placing the product on a bed, sofa, rug, or other similar surface. This product should not be placed in a built-in installation such as a bookcase or rack unless proper ventilation is provided or the manufacturer's instructions have been adhered to.

11. Power Sources

This product should be operated only from the type of power source indicated on the marking label. If you are not sure of the type of power supply to your home, consult your product dealer or local power company. For products intended to operate from battery power, or other sources, refer to the operating instructions.

12. Line-Cord Polarization

This product is equipped with a polarized alternating-current line plug (a plug having one blade wider than the other). This plug will fit into the power outlet only one way. This is a safety feature. If you are unable to insert the plug fully into the outlet, try reversing the plug. If the plug should still fail to fit, contact your electrician to replace your obsolete outlet. Do not defeat the safety purpose of the polarized plug.

13. Power-Cord Protection

Power-supply cords should be routed so that they are not likely to be walked on or pinched by items placed upon or against them, paying particular attention to cords at plugs, convenience receptacles, and the point where they exit from the product.

(Continued on next page)

IMPORTANT SAFETY INSTRUCTIONS

(Continued from previous page)

14. Outdoor Antenna Grounding

If an outside antenna or cable system is connected to the product, be sure the antenna or cable system is grounded so as to provide some protection against voltage surges and built-up static charges. Article 810 of the National Electrical Code (U.S.A.), ANSI/ NFPA 70 provides information with regard to proper grounding of the mast and supporting structure, grounding of the lead-in wire to an antenna discharge unit, size of grounding conductors, location of antenna-discharge unit, connection to grounding electrodes, and requirements for the grounding electrode.

Example of Grounding According to National Electrical Code Instructions

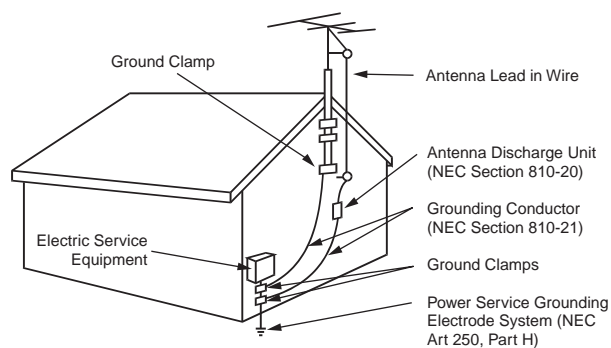

NEC - National Electrical Code

15. Lightning

For added protection for this product (receiver) during a lightning storm, or when it is left unattended and unused for long periods of time, unplug it from the wall outlet and disconnect the antenna or cable system. This will prevent damage to the product due to lightning and power-line surges.

16. Power Lines

An outside antenna system should not be located in the vicinity of overhead power lines or other electric light or power circuits, or where it can fall into such power lines or circuits. When installing an outside antenna system, extreme care should be taken to keep from touching such power lines or circuits as contact with them might be fatal.

17. Overloading

Do not overload wall outlets and extension cords as this can result in a risk of fire or electric shock.

18. Object and Liquid Entry

Never push objects of any kind into this product through openings as they may touch dangerous voltage points or short-out parts that could result in a fire or electric shock. Never spill liquid of any kind on the product.

19. Servicing

Do not attempt to service this product yourself as opening or removing covers may expose you to dangerous voltage or other hazards. Refer all servicing to qualified service personnel.

20. Damage Requiring Service

Unplug this product from the wall outlet and refer servicing to qualified service personnel under the following conditions:

- If the power-supply cord or plug is damaged.
- If liquid has been spilled, or objects have fallen into the product.
- If the product has been exposed to rain or water.
- If the product does not operate normally by following the operating instructions. Adjust only those controls that are covered by the operating instructions as an improper adjustment of other controls may result in damage and will often require extensive work by a qualified technician to restore the product to its normal operation.
- If the product has been dropped or the cabinet has been damaged.
- If the product exhibits a distinct change in performance.

21. Replacement Parts

When replacement parts are required, be sure the service technician has used replacement parts specified by the manufacturer or have the same characteristics as the original part. Unauthorized substitutions may result in fire, electric shock, or other hazards.

22. Safety Check

Upon completion of any service or repairs to this product, ask the service technician to perform safety checks to determine that the product is in proper operating condition.

23. Wall or Ceiling Mounting

The product should be mounted to a wall or ceiling only as recommended by the manufacturer.

24. Heat

The product should be situated away from heat sources such as radiators, heat registers, stoves, or other products (including amplifiers) that produce heat.

Hook-Up Directory

IMPORTANT!!

Use this page to decide where you need to begin your setup. First, find the line below that best describes what you want to do, then go to that page number.

Antenna only

If you are using an antenna and no other equipment, go to page 6

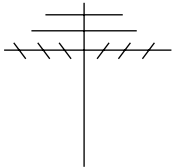

Cable only

If you have cable service or a cable box and no other equipment, go to page 7

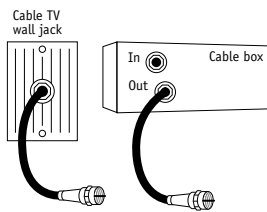

Antenna with VCR

If you are using an antenna and have a VCR, go to page 8

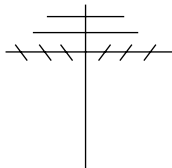

Cable and VCR

If you have cable service or a cable box and a VCR, go to page 9

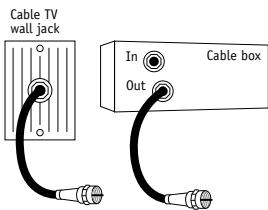

Hook Up Your Antenna to the TV

Connect an antenna to your Entertainment Machine.

1 Locate the Antenna/Cable jack on the back of your Entertainment Machine.

2 Connect the cable that runs from the wall directly to this jack, according to the diagram to the right.

3 Remove the back of the remote and put in two AAA batteries.

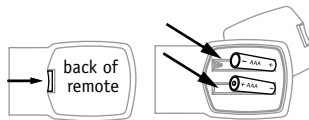

4 Plug in your Entertainment Machine. Do not plug it into a switched outlet. Your Entertainment Machine is designed to operate on household current, 120-volt 60 Hertz AC do not attempt to operate it on DC Current.

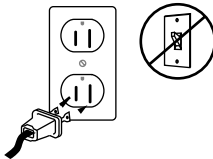

5 Go to page 12 to EZ Program your Entertainment Machine.

 If you have a 75 ohm RF cable, then you don't need any adapters!

 Remember, when screwing RF cables onto jacks, clockwise tightens, and counterclockwise loosens.

Flat wire antenna to Entertainment Machine

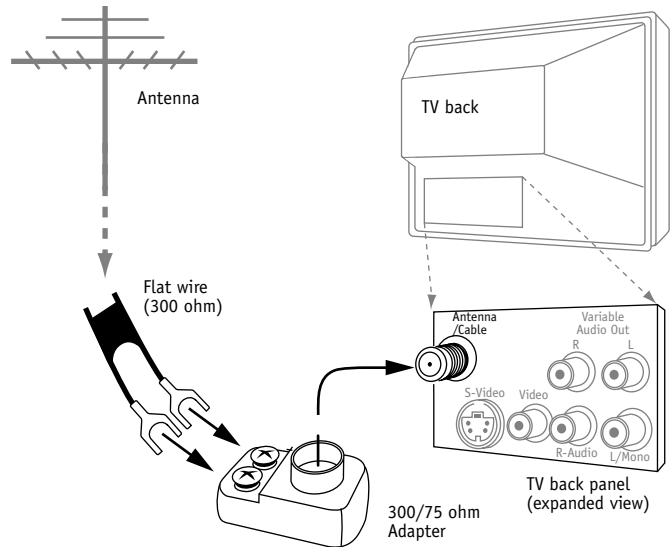

Antenna to Entertainment Machine

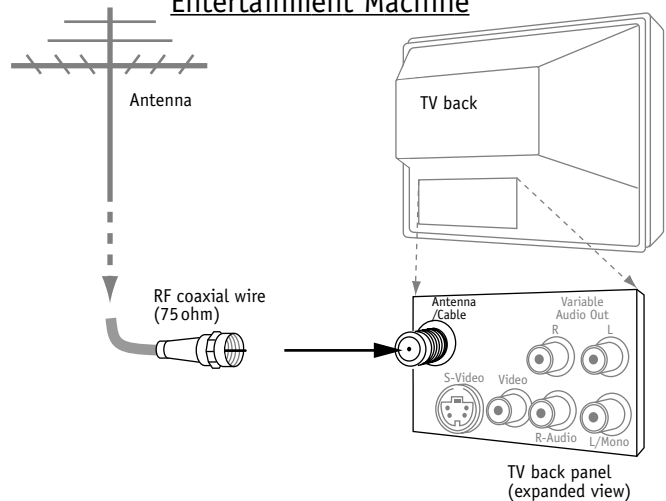

Mini glossary

75 OHM RF CABLE	The wire that comes from an off-air antenna or cable service provider. Each end looks like a hex shaped nut with a wire sticking through the middle, and it screws onto the threaded jack on the back of your Entertainment Machine.
300 TO 75 OHM ADAPTER	A small device that connects a two-wire 300 ohm antenna to a 75 ohm RF jack. They are usually about an inch long with two screws on one end and a round opening with a wire sticking out on the other end.

Hook Up Your Cable Service (CATV)

Connect cable service to your Entertainment Machine.

1 Locate the Antenna/Cable jack on the back of your Entertainment Machine.

2 Connect the cable that runs from the wall directly to this jack, according to the diagram to the right.

3 Remove the back of the remote and put in two AAA batteries.

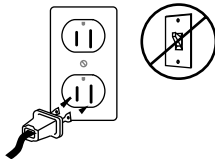
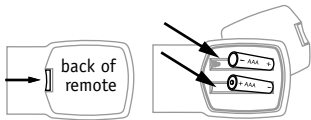

4 Plug in your Entertainment Machine. Do not plug it into a switched outlet. Your Entertainment Machine is designed to operate on household current, 120-volt 60 Hertz AC do not attempt to operate it on DC Current.

5 Go to page 12 to Auto Program your Entertainment Machine.

 *If you're using a cable box, leave your TV on channel 3 or 4 and use your cable box to change channels.*

 *Remember, when screwing RF cables onto jacks, clockwise tightens, and counterclockwise loosens.*

 *If you're using a cable box, Auto- Program might only find the channel your cable service is on (usually channel 3 or 4). Don't worry, that's all you need!*

Without Cable Box

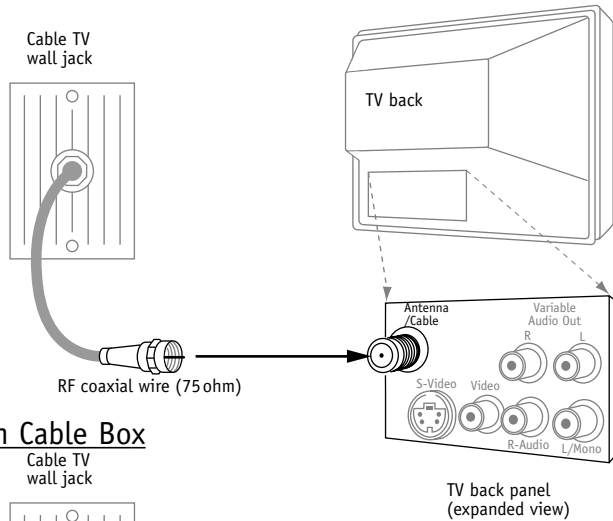

With Cable Box

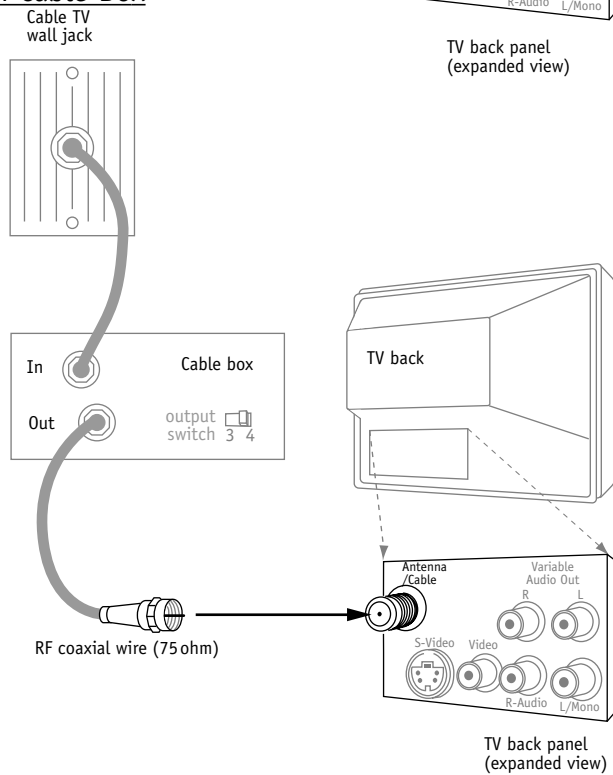

Mini glossary

CABLE SERVICE The wire that supplies all your cable TV (CATV) stations.

Hook Up Your Antenna and VCR

Connect an antenna to your Entertainment Machine.

1 Locate the Antenna/Cable jack on the back of your Entertainment Machine.

2 Connect the cable that runs from the wall directly to this jack, according to the diagram to the right.

3 Remove the back of the remote and put in two AAA batteries.

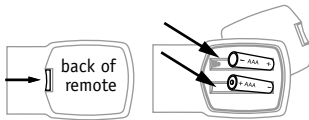

4 Plug in your Entertainment Machine. Do not plug it into a switched outlet. Your Entertainment Machine™ is designed to operate on household current, 120-volt 60 Hertz AC do not attempt to operate it on DC Current.

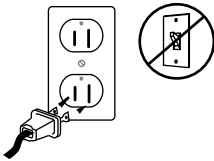

5 Go to page 12 to Auto Program your Entertainment Machine.

 If you have a 75 ohm RF cable, then you don't need any adapters!

 Remember, when screwing RF cables onto jacks, clockwise tightens, and counterclockwise loosens.

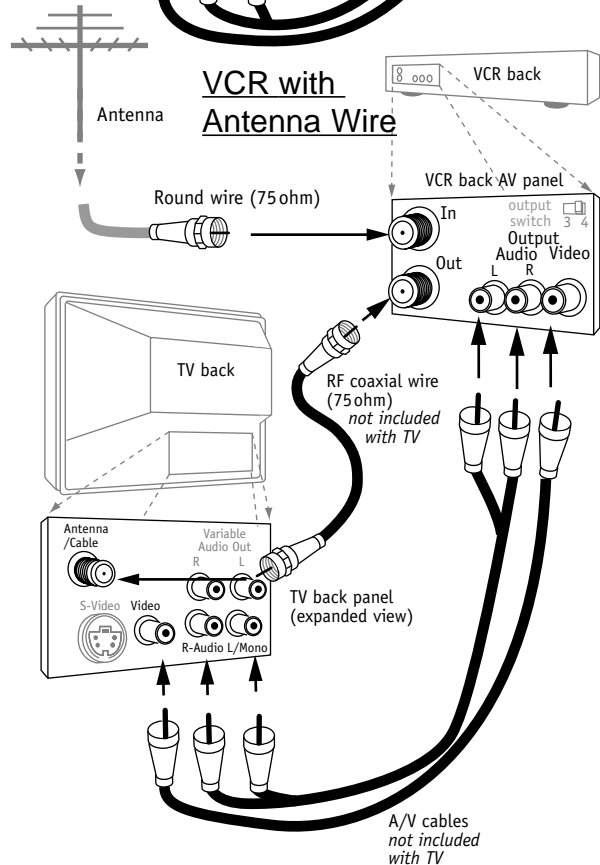
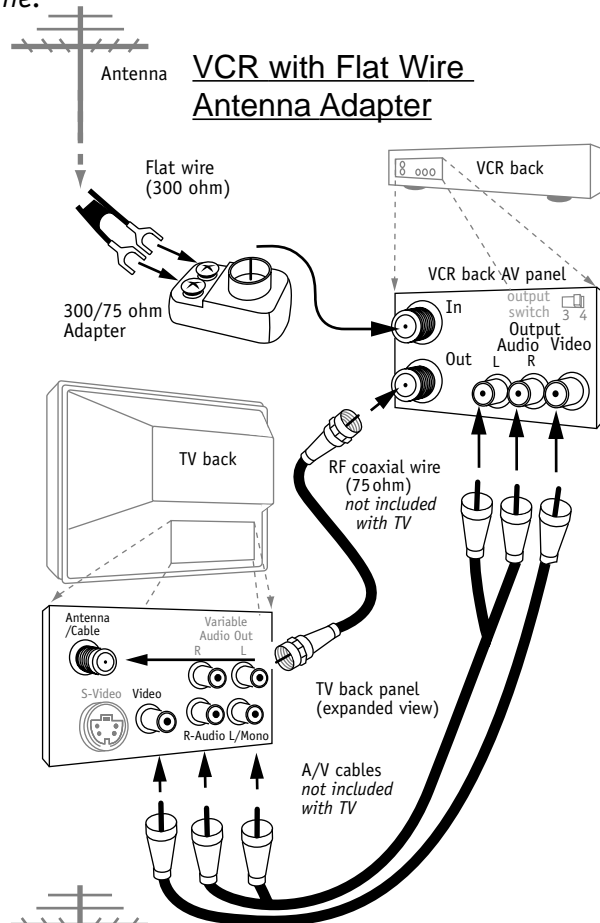

Hook Up Your Cable (CATV) and VCR

Connect cable service and a VCR to your Entertainment Machine.

1 Locate the Antenna/Cable jack on the back of your Entertainment Machine.

2 Connect the cable that runs from the wall directly to this jack, according to the diagram to the right.

3 Remove the back of the remote and put in two AAA batteries.

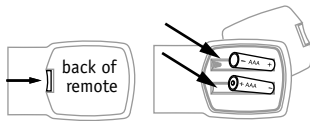

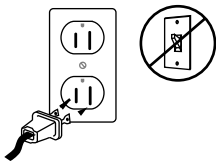

4 Plug in your TV. Do not plug it into a switched outlet. Your Entertainment Machine is designed to operate on household current, 120-volt 60 Hertz AC do not attempt to operate it on DC Current.



5 Go to page 12 to Auto Program your Entertainment Machine.

 Leave your VCR and your television tuned to channel three and use the cable box to change channels.

 Remember, when screwing in RF cables onto jacks, clockwise tightens and counterclockwise loosens.

 Without A/V cables, most VCRs will not play videocassettes in stereo sound.

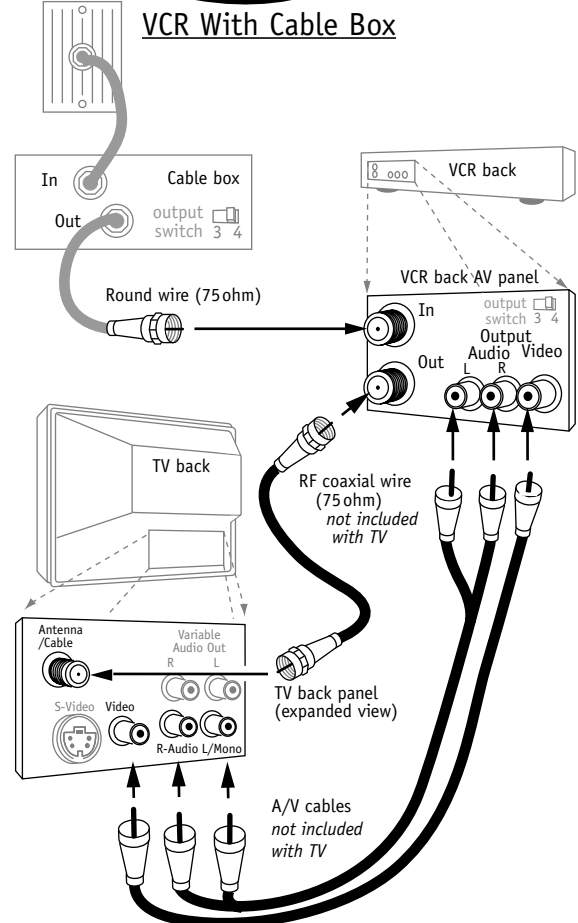
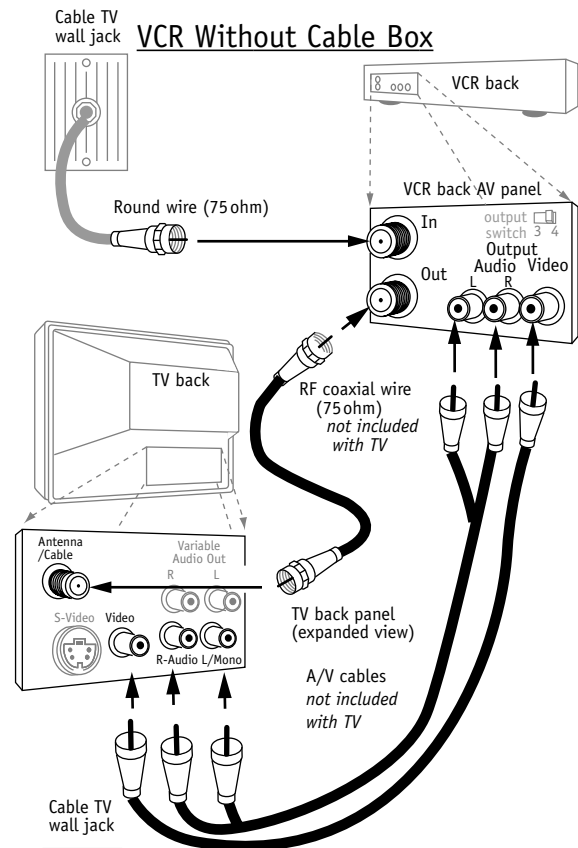

Hook Up Your TV to a Super VHS VCR

Connecting an S-VHS player to your Entertainment Machine.

- 1 Locate the S-Video Out to TV jack on the back of your S-VHS VCR. Connect the S-VHS cable directly to this jack.
- 2 Connect this cable from the Out to TV jack to the S-Video jack on the back of your TV.
- 3 Find the audio and S-Video jacks on the back of S-VHS player and connect them following the instructions provided with your equipment.

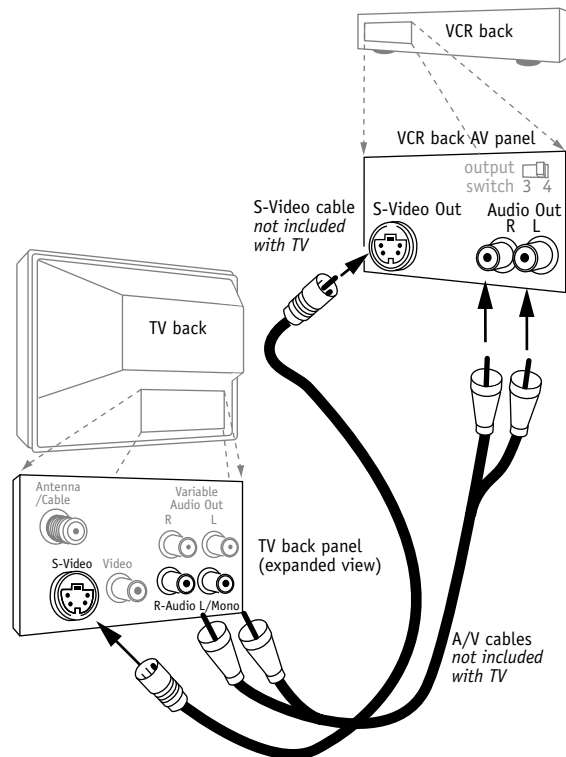

No S-Video cables are included with your Zenith Entertainment Machine but they can be purchased in most consumer electronics stores. Without an S-Video cable, you will not receive the Super VHS quality picture.

Hook Up Your TV to a Stereo Amplifier

Connecting your Entertainment Machine to a stereo amplifier.

For added audio depth and clarity, you can connect your Entertainment Machine to a stereo amplifier.

1 Locate the Left/Right Audio Input jacks on the back of your stereo amplifier. Connect the Audio cables directly to these jacks.

2 Connect these cables from the Left/Right Variable Audio Input jacks to the corresponding Left/Right jacks on the back of your TV.

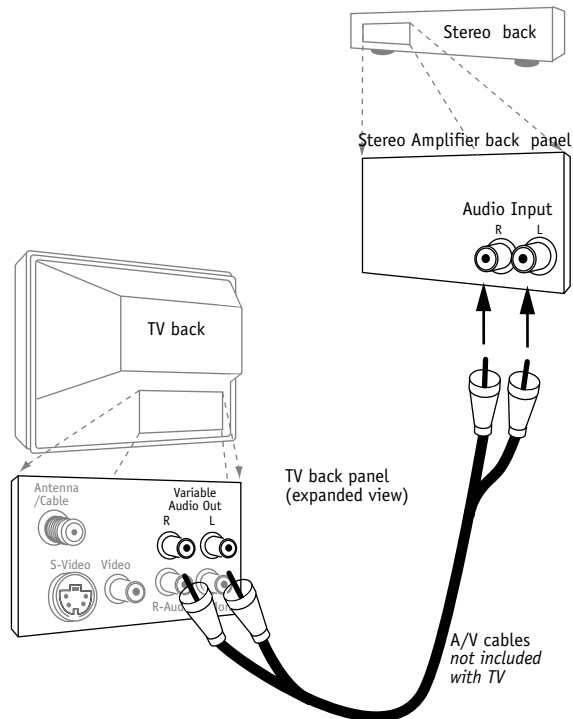

No Audio cables are included with your Zenith Entertainment Machine but they can be purchased in most consumer electronics stores.

EZ Program

Use EZ Program to automatically find and store all of the stations available in your area.

ANTENNA: If your signal source is an indoor/outdoor antenna.

CABLE: If you get your signal from a cable service.

Setup Menu

EZ Program
Add/Del/Surf
Clock Set
Captions
Caption/Text
Language

◀▶ To Program

- 1 With the remote control in hand, press the POWER button to turn on your Entertainment Machine.
- 2 Press the MENU key so the Setup menu appears.
- 3 Using the UP/DOWN arrows on the remote control, select EZ Program on your screen.
- 4 Press a RIGHT or LEFT arrow to reach the EZ Program screen.
- 5 Using the UP/DOWN arrows, choose either Cable TV or Off-Air Antenna on your screen.
- 6 When you have made your selection, press a RIGHT or LEFT arrow to begin EZ Program.
- 7 Press ENTER to return to TV viewing.

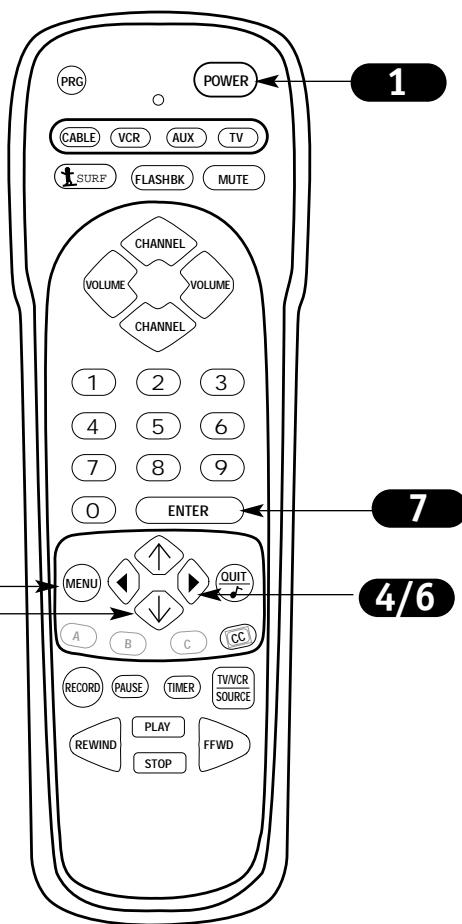

If you are receiving your signal from an antenna, select Antenna in the EZ Program menu when it appears on screen. If you have cable service, select Cable.

Mini glossary

EZ PROGRAM EZ Program is how your Entertainment Machine finds all the channels available in your area and stores them into memory.

The Buttons on Your Remote

A quick list of all of the buttons on the remote and what they do.

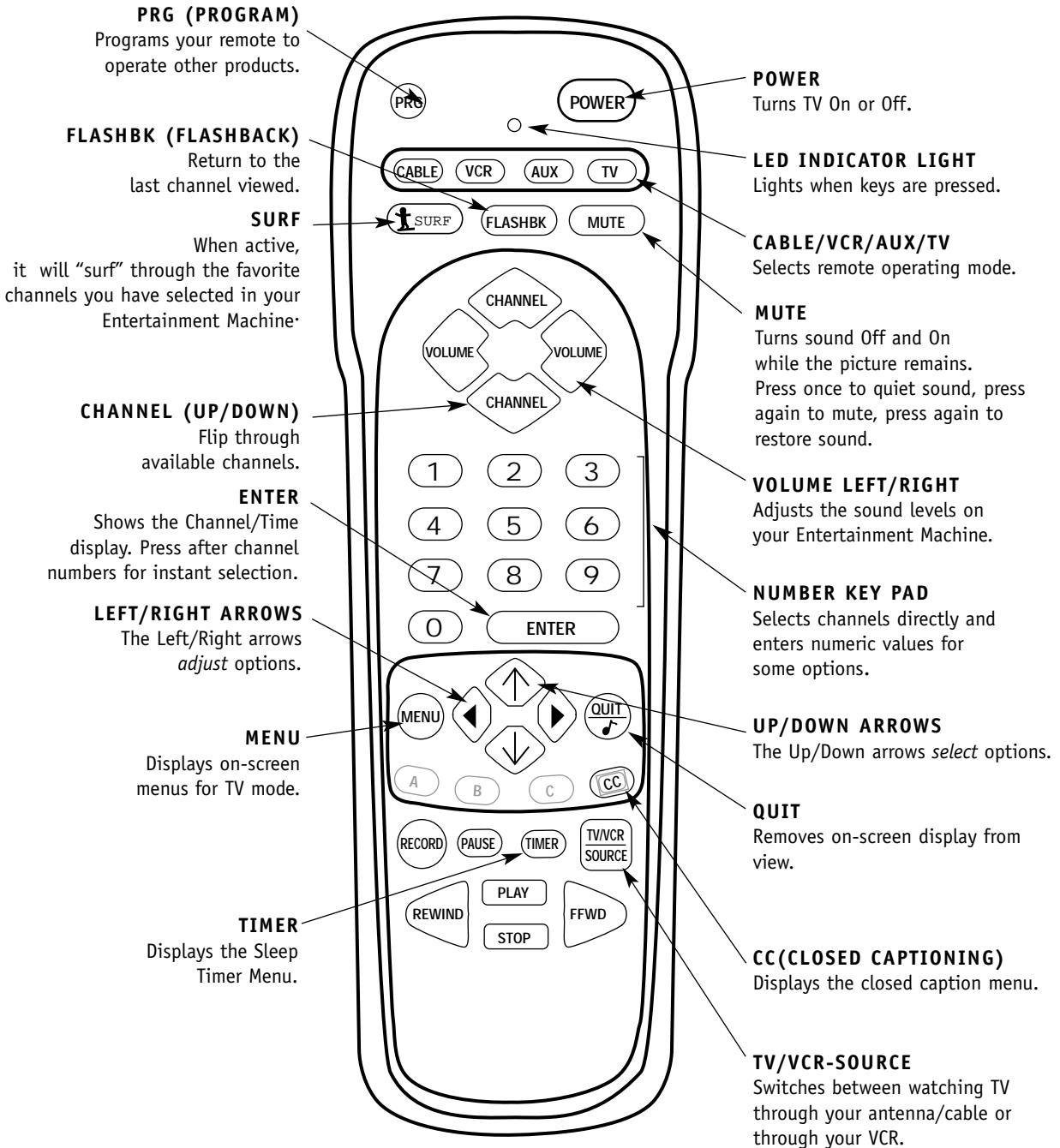

Keys dedicated to VCR functions will still operate your VCR while the remote is in TV mode.

remote control part number
MBR3447Z
(124-233)

Front Panel Diagram

There are three different front panel button styles used with this Operating Guide. Select the front panel that resembles the Entertainment Machine you are using and learn what each button operates and controls.

Six Button Front Panel

When using the on-screen menus, the buttons on the front panel of these models correspond to the remote control buttons as follows:-

VOLUME = Adjust Left/Right
CHANNEL = Select Up/Down

- 1** To access the on screen menus, press the MENU button repeatedly on the front panel.
- 2** Choose the menu and then the function you wish to change using the CHANNEL UP/DOWN buttons. The Channel buttons act as a "select" (Up/Down) function.
- 3** The VOLUME buttons act as an "adjustment" (Left/Right) function. Use the VOLUME buttons to make changes or adjustments.

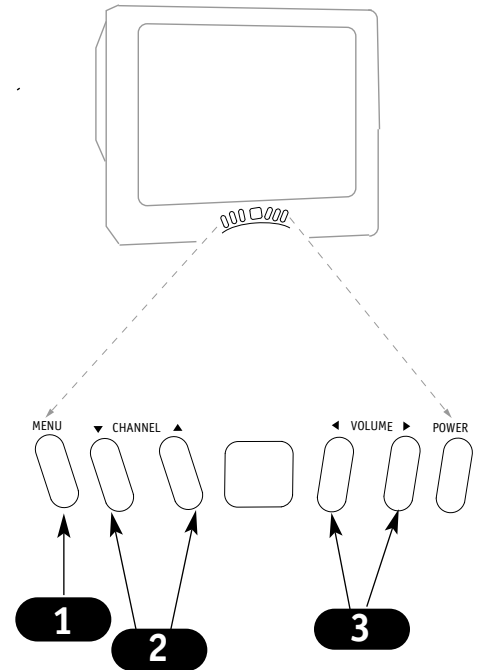

Ten Button Front Panel

- 1** To access the Setup menu, press the MENU button repeatedly until the Setup Menu appears on screen.
- 2** Press the Select button to choose the function you wish to change.
- 3** Use the ADJUST buttons to make changes or adjustments.
- 4** Press the Enter button to clear the screen.
- 5** The Volume and Channel rocker buttons control Volume Up/Down and Channel Up/Down only.

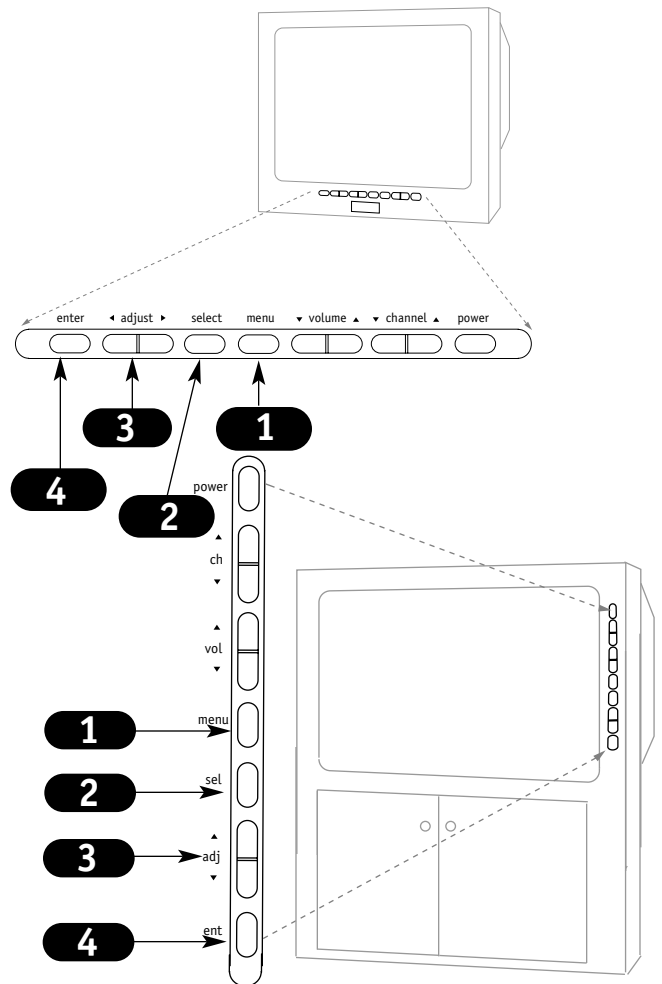

Menus disappear after five seconds. To get them back, push the MENU button again.

Basic Television Operation

Introducing you to the basics of your Entertainment Machine.

Source

On some models, the A/V input is designated as a channel that is one below the lowest/one above the highest.

You'll have to use the Channel Up/Down buttons to access it. The Time/Channel display will read "Video" in place of a channel number.

Cable/Antenna Input: This setting allows you to change cable or antenna channels and to view videocassettes on channel 3 (or 4) in mono sound.

Video Input: This setting allows stereo playback of videocassettes. The television cannot change channels in the Video mode, but the VCR can.



To view the current input source, press ENTER on your remote. The Time/Channel display should appear in the upper right hand corner of the screen. If the display reads 'Video,' then the source is an A/V input. If the display reads a channel number, then the source is your Cable or Antenna.

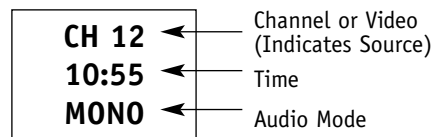

Channel Changing

CHANNEL UP/DOWN arrows: Use these arrows to change the channels. Auto program will have found all channels available to you.

NUMBER Key Pad: To skip to any channel, enter the number of the channel using the NUMBER key pad, then press ENTER.

FLASHBACK: To instantly return to the last channel viewed, press FLASHBACK.

Audio

Volume Right/Left: To adjust the volume level, use the volume Right/Left arrows.

Press MUTE to quiet the sound (Soft Mute).

Press MUTE a second time to remove the sound entirely (MUTE).

Press MUTE a third time to restore the sound.

Setup Menu

Here are descriptions of the menu options found in the Setup menu.

Function	What it does	Go to page
EZ Program	Automatically finds and stores active channels to flip through using Channel Up/Down.	12
Add/Del/Surf	Manually pick and choose which active channels will appear when flipping through using Channel Up/Down. Use the Surf feature to select just the channels you wish to have on your favorite channel scan.	17
Clock Set	Sets the current time on your Entertainment Machine.	18
Captions	Switches the Captions feature On and Off and EZ Mute.	19
Captions/Text	Displays closed captions or text when available. Options are Caption 1, Caption 2, Caption 3, Caption 4, Text 1, Text 2, Text 3, and Text 4.	20
Language	Selects language for on-screen menus. Your options are English, Spanish, or French.	21

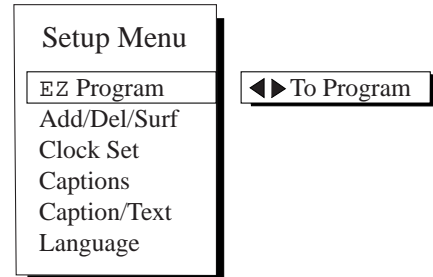

This is an example of what on-screen menus look like.

Setting Add/Del/Surf

Customize your channel selection.

Setup Menu

EZ Program
Add/Del/Surf
 Clock Set
 Captions
 Caption/Text
 Language

Ch 9 Added

- 1** Press the MENU key on the remote so the Setup menu appears.
- 2** Select the Add/Del/Surf menu using the UP/DOWN arrows.
- 3** Using either the NUMBER key pad or the CHANNEL UP/DOWN arrows on the remote, select a channel. (If adding a deleted channel, you will need to use the NUMBER key pad.)
- 4** Using the RIGHT/LEFT arrows, select either Add, Surf or Delete for that particular channel.
- 5** To continue, select another channel and repeat step 4. If you are finished, press ENTER to return to TV viewing.



You can add or delete a channel without the remote control. Please refer to page 14 on working the menus with the buttons on the front of your Entertainment Machine.



If you delete a channel, it isn't gone for good. Just select it using the NUMBER key pad on the remote or add it later.

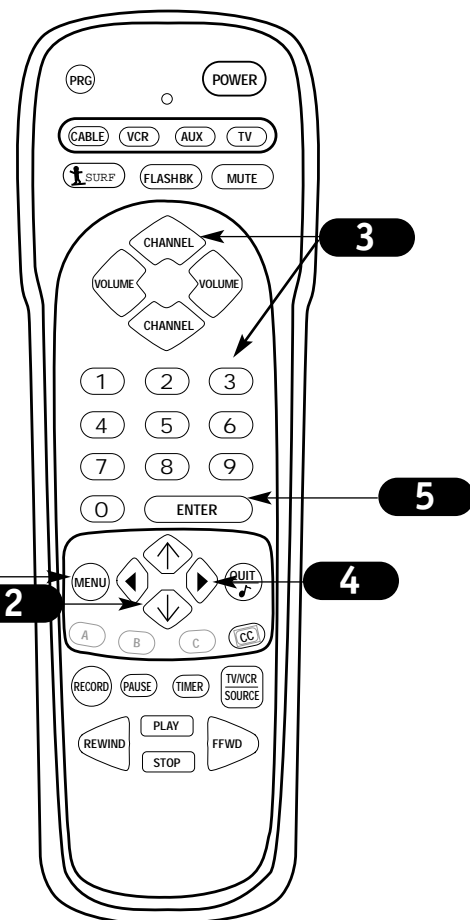

Mini glossary

- ADD** This function lets you add new channels to the list that you'll scroll through when using your remote.
- DELETE** This function lets you remove channels that you don't watch from the list you'll scroll through.
- SURF** This function creates a customized list of your favorite channels.

Clock Set

Set the clock on your Entertainment Machine.

Setup Menu

EZ Program
Add/Del/Surf
Clock Set
Captions
Caption/Text
Language

8:55 AM ← FLASHBK

- 1 Press the MENU key on the remote control so that the Setup menu appears onscreen.
- 2 Using the UP/DOWN arrows on the remote control, select Clock Set on your screen.
- 3 Press a RIGHT or LEFT arrow to adjust the time or enter the time using the digits on the remote control.
- 4 Press the FLASHBK button to select AM or PM.
- 5 Press ENTER to return to TV viewing.



You can use the NUMBER key pad to simply insert the time (AM or PM is selected with the Flashback key).

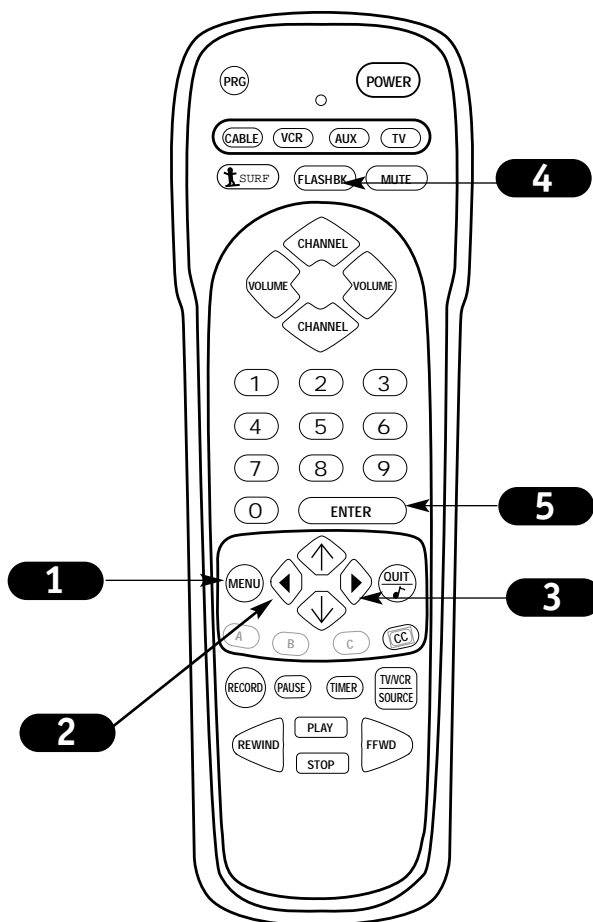

Captions

Turn the captions feature on your Entertainment Machine on or off.

Setup Menu

EZ Program
Add/Del/Surf
Clock Set
Captions
Caption/Text
Language

Mute

1

Press the MENU key on the remote control so that the Setup menu appears.

2

Using the UP/DOWN arrows on the remote control, select Captions on your screen.

3

Press a RIGHT/LEFT arrow to switch the captions feature on, off or EZ Mute.

4

Press ENTER to continue.

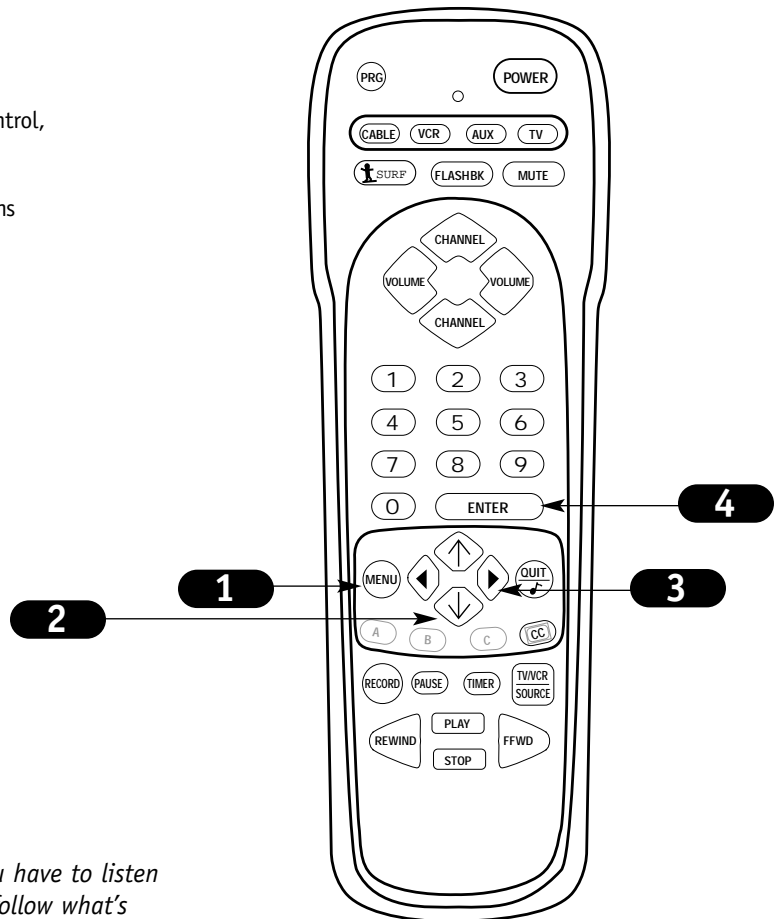

Use the captions feature when you have to listen to a phone call and still want to follow what's happening on your favorite show.

Captions / Text

Select closed captioning or text that appears at the bottom of your screen.

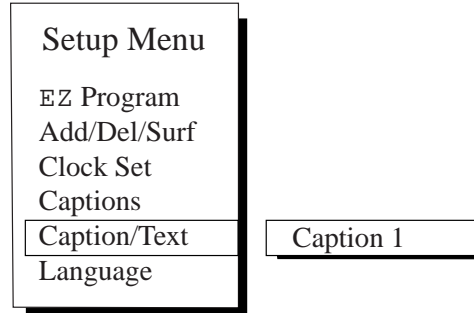

- 1** Press the MENU key on the remote control so that the Setup menu appears.
- 2** Using the UP/DOWN arrows on the remote control, select Captions/Text on your screen.
- 3** Press a RIGHT/LEFT arrow to choose any of the following options: Caption 1, Caption 2, Caption 3, Caption 4, Text 1, Text 2, Text 3 or Text 4.
- 4** Press ENTER to return to TV viewing.



Captions come in handy when the television is on mute.



Standard Closed Captioning is available using the Caption 1 option.



Not all programming has closed captioning or text available.

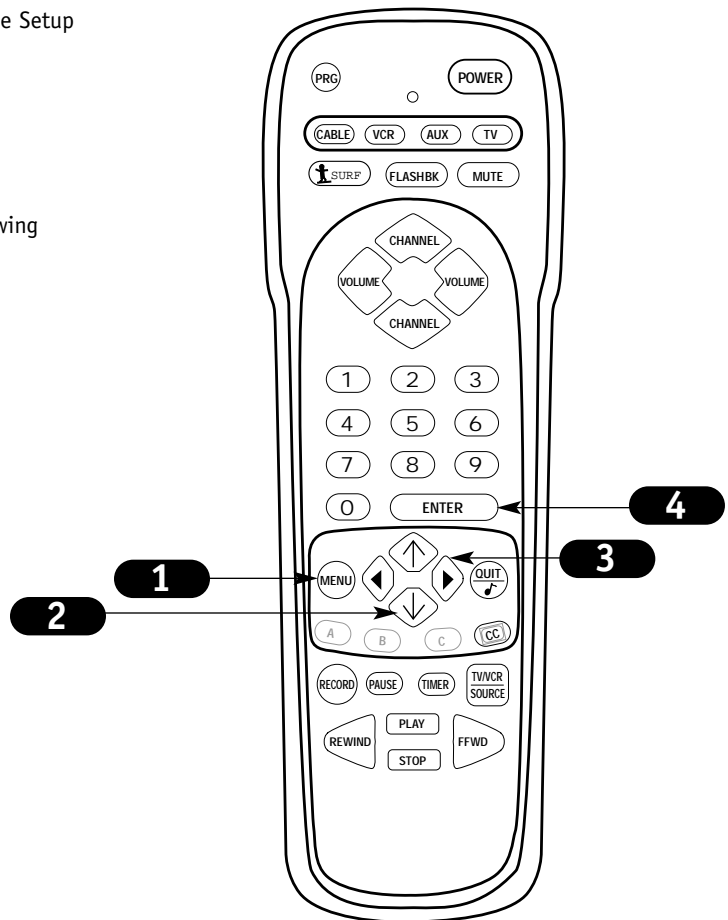

Language Options

Choose the language you want all of the menus to appear in.

Setup Menu

EZ Programac
Agr/Bor/Surf
Ajuste Reloj
Subtít
Subtít/Texto

Language

Spanish

- 1 Press the MENU key on the remote control so that the Setup menu appears.
- 2 Using the UP/DOWN arrows on the remote control, select Language on your screen.
- 3 Press a RIGHT/LEFT arrow to choose any of the following options: English, Spanish, or French.
- 4 Press ENTER to return to regular TV viewing.

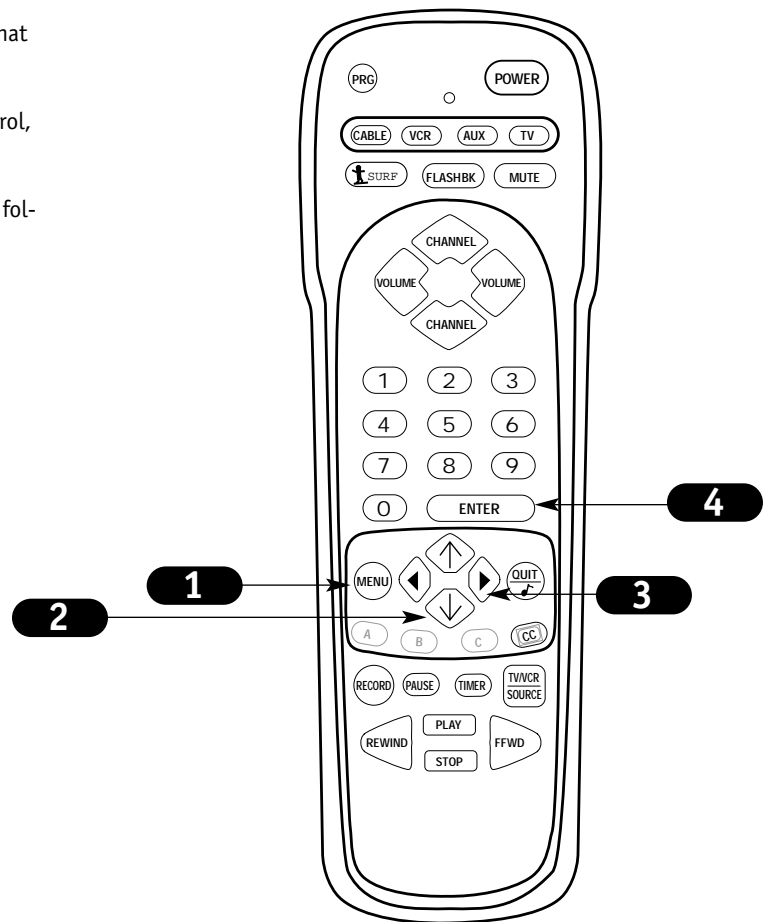

EZ Timer, Sleep Timer Setup

Set your Entertainment Machine to automatically turn on and off.

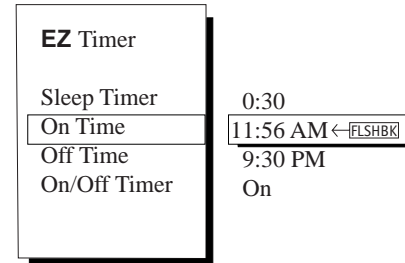
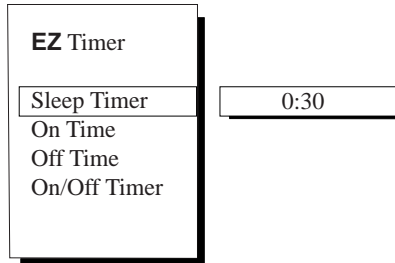

- 1** Press the MENU key repeatedly until the Special Features menu appears on screen.
- 2** Select EZ TIMER, using the UP/DOWN arrow keys.
- 3** Press a RIGHT/LEFT arrows to choose the time (10 minutes up to 4 hours) that you want your TV to turn itself off.
- 4** If you want the TV to turn on and off automatically every day use the UP/DOWN arrow keys, select ON TIME and use the RIGHT/LEFT keys to set the time you want the TV to turn itself on.
- 5** Once again, using the UP/DOWN arrow keys, select OFF TIME. Use the RIGHT/LEFT keys to set the time you want the TV to turn itself off.
- 6** Using the UP/DOWN arrow keys, select ON/OFF TIMER. Use the RIGHT/LEFT keys to select ON or OFF. The Timer feature is now set.
- 7** Press ENTER to return to normal viewing.

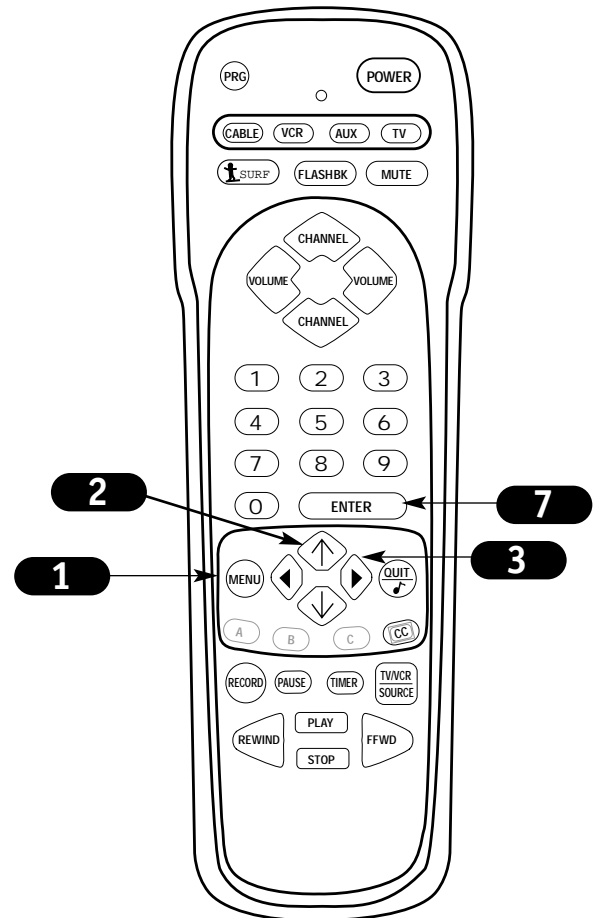

Channel Labels

Choose preset labels or call letters for your channels.

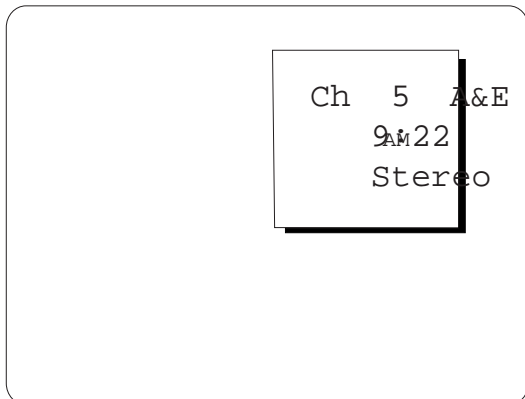

Channel/Time Display with Channel Label

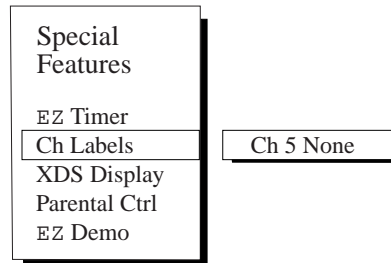

- 1** Press the MENU key repeatedly until the Special Features menu appears on screen.
- 2** Select CH LABELS, using the UP/DOWN arrow keys.
- 3** Press a RIGHT/LEFT arrows repeatedly to choose the correct Call Letters or Channel Letters from the 84 selections included.
- 4** Enter the next channel you wish to label and repeat 3 until all of the channels have a Channel Label.
- 5** Press ENTER to return to normal viewing.



If your cable service should change your channel lineup at any time, you can reset all of the labels again.

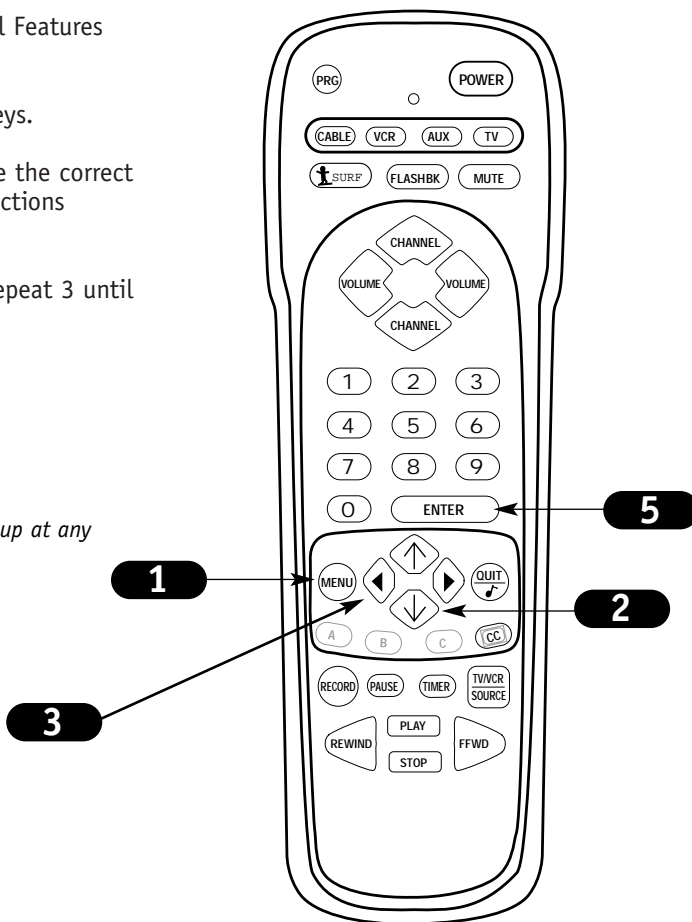

XDS Display Menu

Use the Extended Data Service to show in-depth program information.

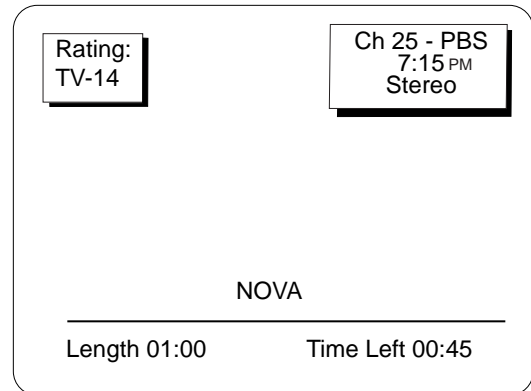
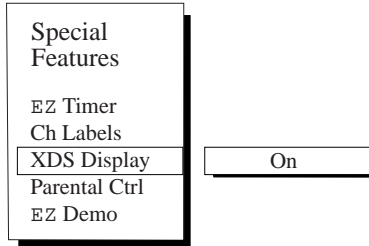

- 1** Press MENU on the remote repeatedly until the Special Features menu appears.
- 2** Highlight the XDS Display option using the Select UP and DOWN arrows.
- 3** Use either the RIGHT or LEFT arrow to specify On or Off.
On - - XDS Display will appear as channels are changed.
Off - - XDS Display will not appear when channels are changed.
- 4** Press QUIT to return to TV viewing.



At the time of this printing, XDS data is only being carried by some broadcasting stations and as a result, is only available on some channels.



Even though XDS data may be present, it may not be available during commercial or network breaks.

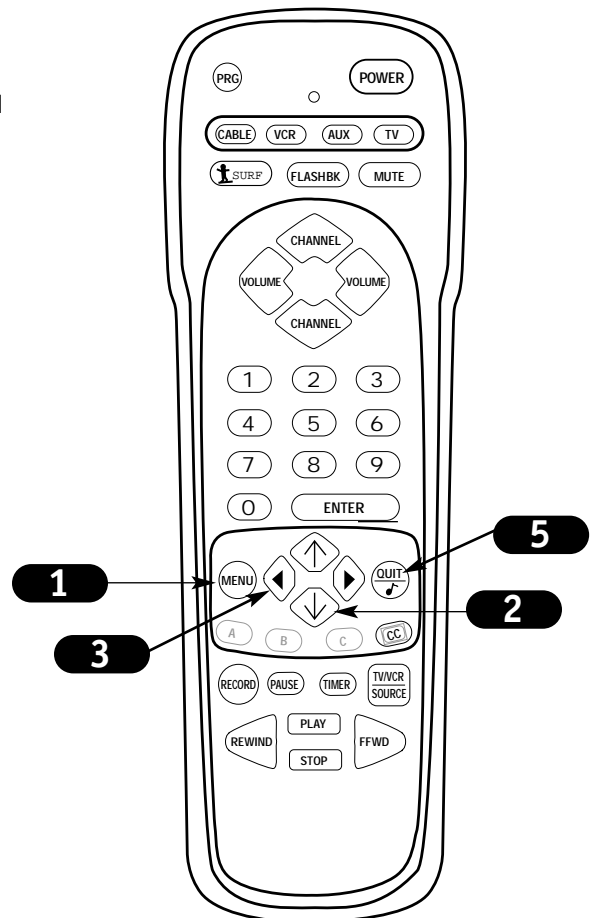

Mini glossary

XDS

Extended Data Service - - if provided by the broadcaster, may show some or all of the following information:

Channel/Time/Audio display/Network label, if present. Title of program, Length of program in hours and minutes and the Time remaining on the program in hours and minutes.

This feature offers a wide variety of options and settings that restrict or “block” undesirable programming from appearing on your TV screen.

AN OVERVIEW

Parental Control allows the user the capability of defining which program rating they consider acceptable to the younger or more sensitive viewer. It can be preset and turned either on or off by the user who specifies the secret 4-digit code. The number of hours blocked can be specified. General audience and children viewer blocks can both be programmed into the TV's memory. Viewer ratings are specified for both TV and the motion picture industry; both rating systems can be used. These ratings are based mainly on the ages of children.

Below are listed explanations of each of the blocking options and a guide to help you access and select the Parental Control option best suited for your viewing environment.

Aux. Block: Allows you to block the signal sent by equipment connected to the TV Audio/Video input jacks such as a VCR, a DVD Player, Laser Disc Player, etc. So, if you do not wish somebody to watch a videotape, a Laser Disc, etc, just set the Aux. Block to **Sources Blocked**.

MPAA: The Motion Picture Association of America's Rating system has been included for those people who may be more familiar with this rating system. (See layout on next page). There are six levels of settings. They are: **G and Above, PG and Above, PG-13 and Above, R and Above, NC-17 and Above** and **X**. Press LEFT or RIGHT arrowsto access.

Age Block: You may wish to use these ratings instead. They are divided into two groups, General and Children.
GENERAL: These settings are: **TV-G and Above, TV-PG and Above, TV-14 and Above** and **TV-MA**.
CHILDREN: These settings are: **TV-Y and Above** and **TV-Y7**. Press to access.

Content Block: Once again, there are six designated blocks that you can access. They are: **Dialog, Language, Sex Scenes, Violence, F Violence** and **No Rating**. These settings allow you the option to block the program “Content” based on individual parameters such as: Strong Dialog, Bad Language, Sex Scenes, Violence Scenes or Fantasy Violence Scenes and then to select an age level as well. Press LEFT or RIGHT arrows to access.
NOTE: If you choose TV-PG, all of the more restrictive ratings will be automatically blocked. This means that the viewer will not be able to see TV-PG, TV-14, or TV-MA rated programming.

Set Hours: Use this setting to enter the amount of hours you wish the Advanced TV Control feature to be active.

Set Password: Select a secret password or code, using the number keys on the remote control. Don't forget the password. It is the only way you can access the Advanced TV Control menu and change the rating selections. It is also the only way you can turn the Advanced TV Control feature off.

Lock On Off: This setting gives you the option to have the Advanced TV Control feature active all the time or allow you to turn it on or off as needed.



Simply specifying one content block such as Sex Scenes, will not automatically block another content in the programs from appearing.



Even if you choose to leave the Aux inputs unblocked, the ratings you specify will automatically restrict the programming that appears from the video sources.

Parental Control (Continued)

Determine the programs and video sources your family and friends can or cannot access.

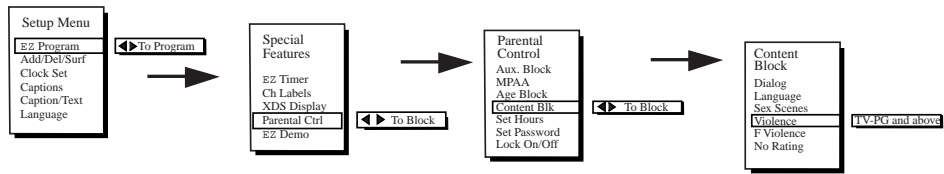

- 1** Press the MENU key repeatedly until the Special Features menu appears on screen.
- 2** Select Parental Control, using the UP/DOWN arrow keys.
- 3/4** Press the RIGHT/LEFT arrows to select Block Channels. Using the UP/DOWN arrow buttons, select MPAA to block channels according to the MPAA guidelines. Select Age Block to block according to Age and Content Block to block channels according to program content.
- 5** If you wish to block a video source (VCR or DVD, etc), press the UP/DOWN arrow keys and select AUX. BLOCK and repeat 3.
- 6** To set the hours you wish the Parental Control feature to be on, press the UP/DOWN arrow keys and select SET HOURS.
- 7** Use the SET PASSWORD feature to insert a four digit code that will make sure no one else can change your settings.
- 8** Finally set the lock to ON to complete the blocking out of the channels or video sources.
- 9** Press ENTER to return to normal viewing.

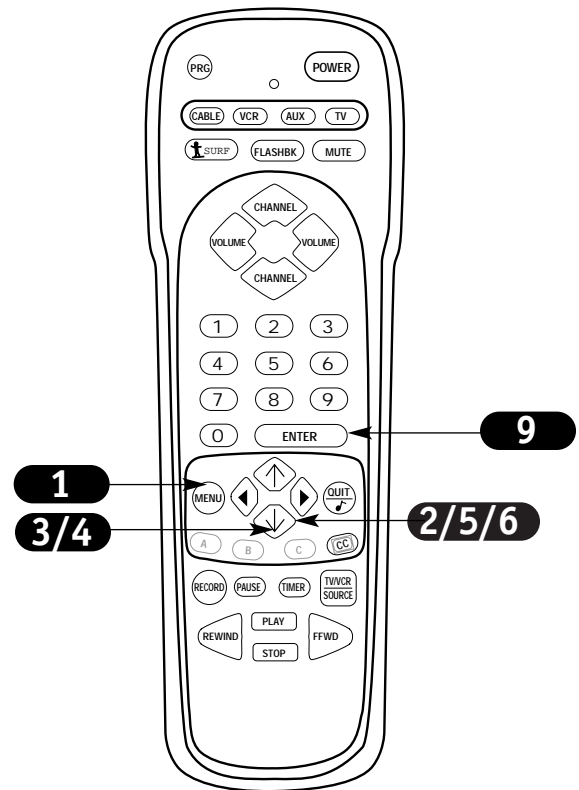

Mini glossary

MOTION PICTURE ASSOCIATION OF AMERICA (MPAA) RATING SYSTEM

G	General Audiences	Content not offensive to most viewers.
PG	Parental Guidance Suggested	Content is such that parents may not want their children to view the program.
PG-13	Parental Guidance Suggested	Program is inappropriate for preteens, with a greater degree of offensive material than a PG rated program.
R	Restricted viewing	Not for children under age 17. Strong elements of sex and/or violence.
NC-17	Restricted Viewing	Not for children under age 17 under any circumstances. Strong sexual content.
X	Hard Core Films	Same as NC-17 rating.

Note: Zenith Electronics Corporation is not liable for any program content that appears when using this rating system; as always, user discretion is advised.



For a complete restriction coverage you should set restrictions for both General and Children in the Age Block Option.

EZ Demo Menu

Your Entertainment Machine will show you all of your Menu options.

Special Features

EZ Timer
Ch Labels
XDS Display
Parental Ctrl

EZ Demo

On

- 1 Press the MENU key on the remote control repeatedly until the Special Features menu appears.
- 2 Using the UP/DOWN arrows on the remote control, select EZ Demo on your screen.
- 3 Press a RIGHT/LEFT arrow to turn the EZ DEMO on or off.
- 4 Press ENTER to continue.

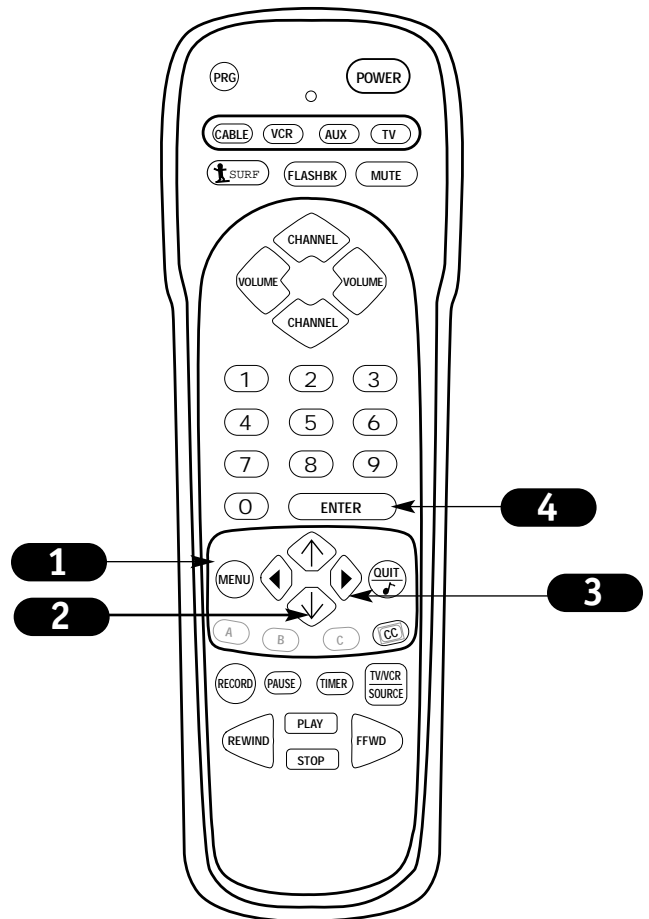

Audio Menu

Personalize the sound coming from your Entertainment Machine.

Audio Menu

Bass
Treble
Balance
Audio Mode
Front Surround
EZ SoundRite
Speakers
EZ Sound

- 1 Press the MENU key on the remote control repeatedly until the Audio menu appears.
- 2 Use the UP/DOWN arrows on the remote control to make your selection.
- 3 Press a RIGHT/LEFT arrow to make an adjustment. Changing the Bass, Treble and Balance levels will alter the sound emanating from the TV's speakers.
 - Select Audio Mode if you want to change the sound from Mono, 2nd Audio/SAP or Stereo.
 - Front Surround gives a sense that the sound is open and expanded.
 - EZ SoundRite scans for changes in sound level during commercials, then adjusts the sound to match your current audio levels. This will make sure that the volume level will be consistent whether you are watching commercials or a regular TV program.
 - The Speakers feature allows you to switch the internal speakers of the TV On and Off. Many people who use a home stereo system with their TV use this feature.
 - EZ Sound allows you to choose an appropriate listening setting based on different audio options. They are: Custom, Normal, Stadium, News, Music and Theater. Normal resets all audio settings to the original levels.
- 4 Press ENTER to return to TV viewing.

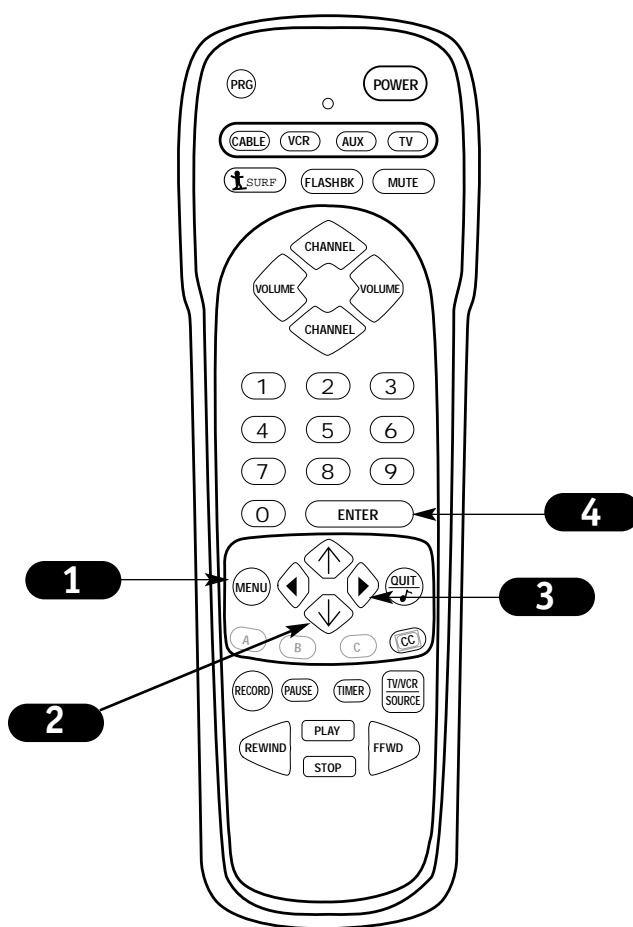

Not all programming is broadcast in stereo.

Video Menu

Customize the way your picture looks using the Video menu.

Video Menu

Contrast
Brightness
Color
Tint
Sharpness
Color Temp

EZ Picture

Digital Preset

1 Press the MENU key repeatedly until the Video menu appears.
Your options are:

- **Contrast:** Adjusts the level of difference between white and black in the TV picture. The more contrast, the brighter the picture appears.
- **Brightness:** Increases or decreases amount of white in the TV picture.
- **Color:** Adjusts levels of all colors in the TV picture.
- **Tint:** Balance between amount of red and green in the TV picture.
- **Sharpness:** Raise or lower the definition of the TV picture. The lower the level, the softer the images will appear.
- **Color Temperature:** select between a warm or a cool color layout to the overall picture.
- **EZ Picture:** Choose either Custom or Preset.
Custom allows you to set the picture the way you want.
Preset moves all the above options back to their original, factory-set levels.

2 Use the UP/DOWN arrows on the remote control to make your selection.

3 Using the RIGHT/LEFT arrows to adjust the level to your preference.

4 Press ENTER, QUIT or MENU one more time to return to TV viewing, or repeat to set the other menu options.

5 Using the Up/Down arrow, select EZ Picture on your screen.

6 Use the RIGHT/LEFT arrows to choose an appropriate viewing setting based on video image options included in your EZ Picture feature. They are: Custom, Normal, Movie, Digital Preset, Video Game, Sports, Weak Signal and Night Time.

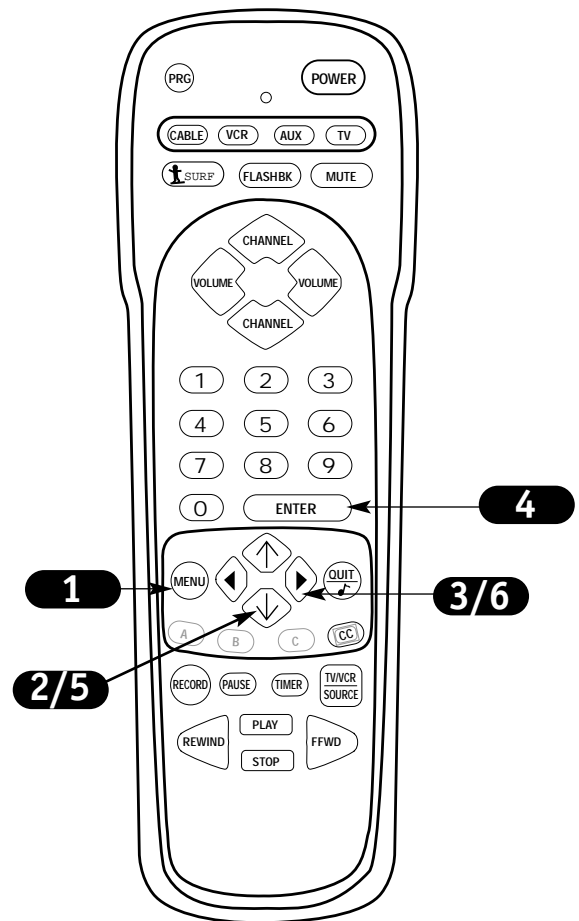

Source Menu

Choose between Antenna/Cable and Video Sources.

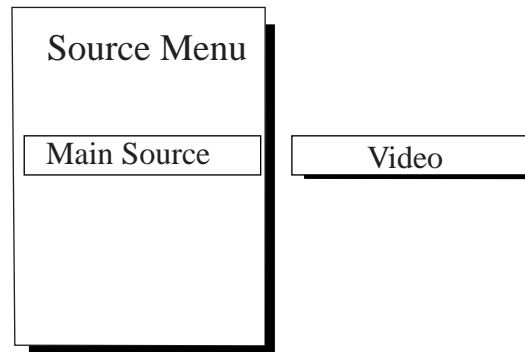

- 1** Press the MENU key on the remote control repeatedly until the Source Menu appears on screen. It will show that the source of the picture on your screen is either coming from your Antenna Cable or from your Video (e.g. Video can be a VCR, a DVD player, etc.)
- 2** Press a RIGHT/LEFT arrow to make an adjustment., changing the signal source from Antenna/Cable to your Video or vice versa.
- 3** Press ENTER to clear the screen.

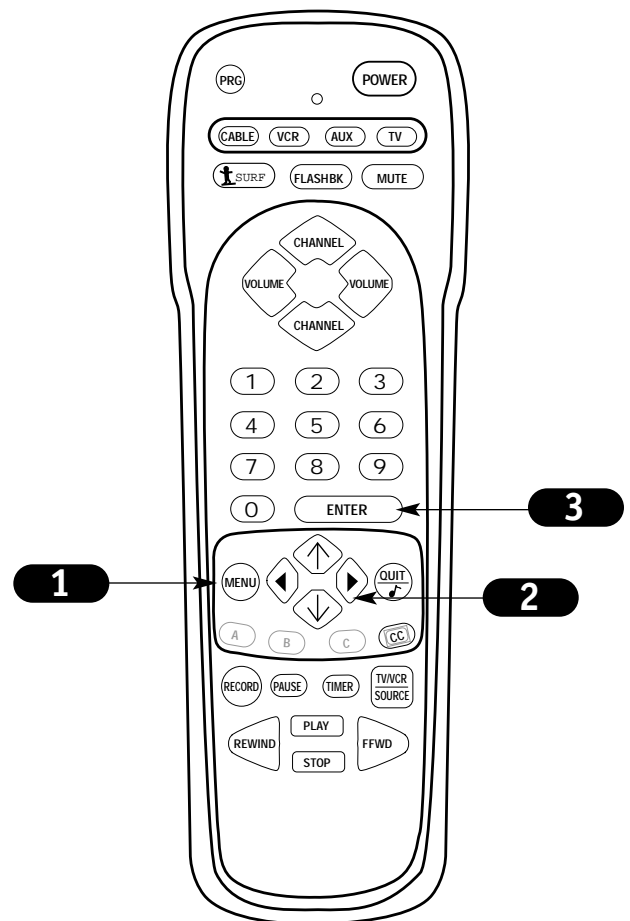

Programming the Remote

Program your remote to work with a vast range of A/V devices.

- 1** The device you want to program should be ON.
- 2** On the chart in this manual, find the type of device you're programming and then find the brand name. Make a note of the three-digit code—you'll need it soon.
- 3** Press and hold the PRG key. It's recessed so it doesn't get pushed accidentally. When indicator light behind the PRG button turns on, you can release the button.
- 4** Push the button with the name of the device you're programming (VCR, CABLE, TV).
- 5** Using the number pad, enter the three digit code found on the chart in the Reference section.
- 6** Press ENTER to save the code. The indicator light will flash three times and turn off if the code was accepted.
- 7** Aim the remote at the device and push the POWER button. It should turn off. If not, try the other codes listed and continue from step three.

Note: After programming, to operate the device you have just programmed, press the proper Mode button first.



Programming your Zenith remote will allow you to use one remote to work up to 7 different devices!



Not all devices will work with your Zenith remote control.

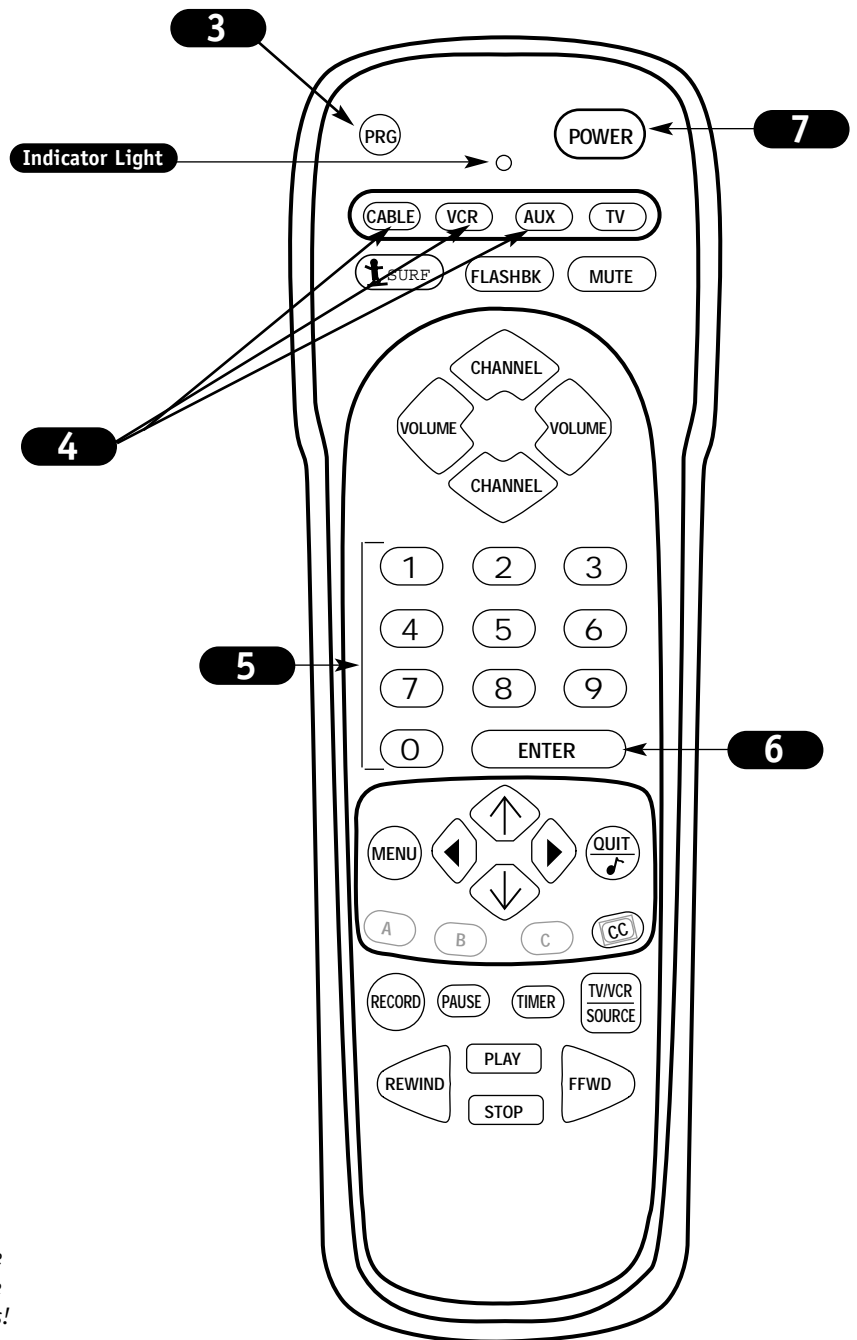

Amplifier Volume Override

Control the volume on your home audio system without changing modes.

- 1** Select the code that operates your amplifier and program it into the mode in which you want the volume to appear (e.g. CABLE or AUX mode), as described on the "Programming the Remote" on page 31.
- 2** Press and hold PRG, using a blunt instrument, on your remote until the indicator light stays lit.
- 3** Press 4-9-9; then ENTER on the remote. The indicator light will flash three times if code is accepted.
- 4** The audio system volume/mute now appears in the mode you have selected.

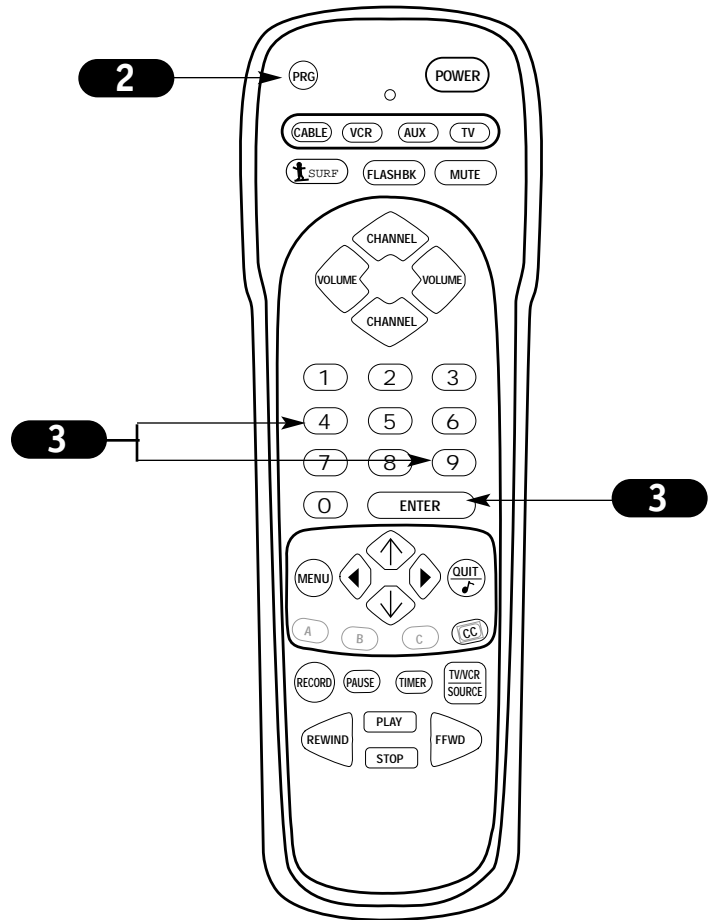

If you can't find the code for your amplifier, use the Auto Find feature on page 34.

Aux+1, Aux+2, Aux+3

Control up to seven devices with your remote!

- 1** Refer to the chart in this manual to find the type and brand name of the device you're programming.
- 2** Press and hold the PRG key until the indicator light turns on.
- 3** Press the AUX key and the 1 on the number pad at the same time (for AUX +1).
- 4** Using the number pad, enter the three-digit code for the device you've selected.
- 5** Press Enter to save the code.
- 6** Aim the remote at the device and press POWER. It should turn on.
- 7** Repeat the steps for AUX+2, and AUX+3.

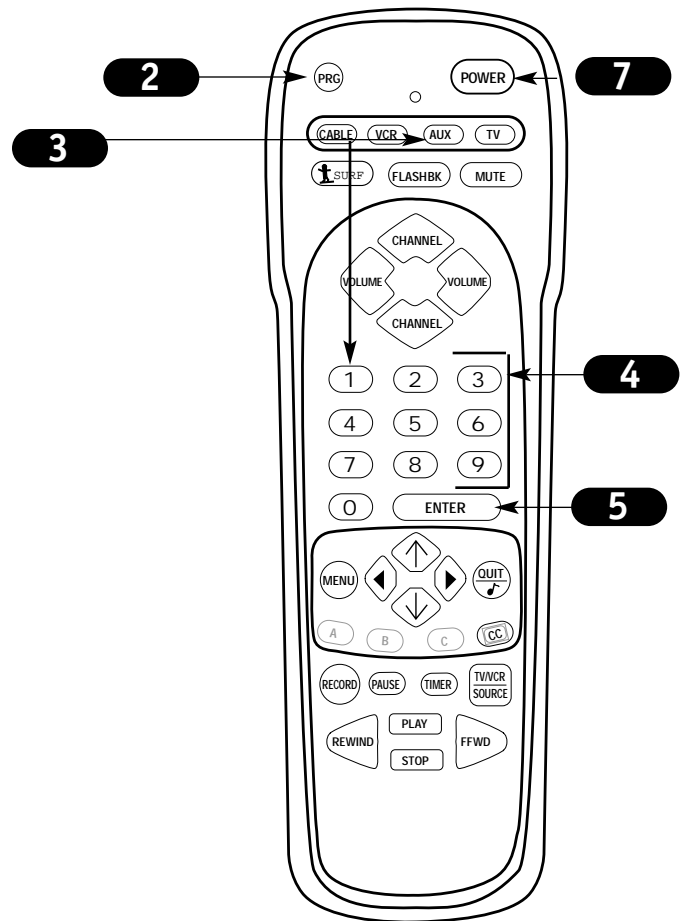

Programming your Zenith remote will allow you to use one remote to work up to 7 different devices!



Not all devices will work with your Zenith remote control.

Remote Control Auto-Find

Use the remote control to search all possible codes.

If Programming the Remote did not find your code, try this procedure to automatically find the code for your device.

- 1 Turn on the device you're programming for the remote control.
- 2 Press and hold the PRG key until the indicator light turns on.
- 3 Press the key for the device you're trying to program (CABLE, VCR, AUX, TV).
- 4 Enter the code 0-0-0 (zero-zero-zero), then press the ENTER key right away.
- 5 Aim the remote at the correct device and press the POWER button. Allow a second to pass, then push the POWER button again. Repeat until the device turns off. (This is a trial and error process, so it may be necessary to repeat these steps until the remote finds your code.)
- 6 Push ENTER to save the code.
- 7 Press POWER to turn the device back on.

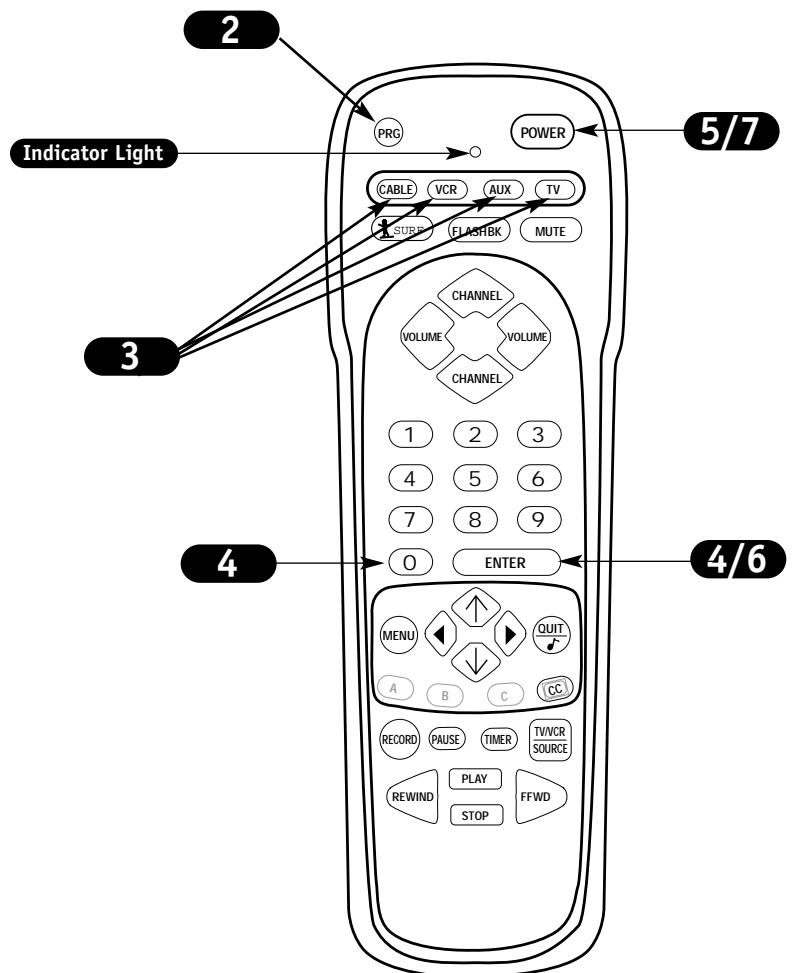

Programming Codes

Find the codes you need to program your remote. On this page: TVs and VCRs.

TVs

Admiral	116 121 130 133	Funai TV/VCR	154	MGA/Mitsubishi. . .	104 119 120 130 140 155	110 111 118 134	
Adventura TV/VCR .	154	General Electric . .	106 107 114 116 117 161	Montgomery Ward .	103 104 105 113 114 119 121 130 133	Sharp	103 105 122 133 137 156 169
Akai	104	Goldstar	103 104 119 147	NEC	104 119	Signature 2000 . . .	103 104 105 113 114 119 121 130 133
Amark	103 146	Goldstar TV/VCR . .	153	Panasonic	106 107 160 166	Sony	115 143 151 170
AOC	104	Hitachi	102 103 129 163	Panasonic TV/VCR .	174	Soundesign	139
Bell & Howell . . .	121	J.C. Penney	104 110 114 117 119	Philco	103 104 112 113 139	Sylvania	112 113 117 119 127 128 139
Broksonic	131 136	JVC	125 132 164	Philips	112 113	Symphonic TV/VCR	154
Candle	139	KMC	103	Pioneer	135	Tatung	106
Centurion	119	KTV	103 104 138	Portland	103	Teknika	103 112 121 124 139
Citizen	121 139	Kurazai	121	ProScan	116 157 162 167	Telerent	103 121
Contec	141	Lodgenet	121	Quasar	106 107	Toshiba	110 111 134 171
Coronado	103	Logik	121	RCA	104 116 126 157 161 162 167 168	XR 1000	121
Crown	103	LXI	133 137	Realistic	105 123 124	Yorx	119
Curtis Mathes . . .	116 119 121	Magnavox	103 112 113 117 119 127 128 139 165	Sampo	119	Zenith	101 149 175
Daewoo	149 159	Magnavox TV/VCR .	173	Samsung	103 119 134 141	Zenith TV/VCR . . .	153 154 172
Daewoo TV/VCR . .	148	Majestic	121	Sanyo	108 109 118		
Daytron	119	Marantz	104 120 155	Scott	119 124		
Elektra	121	Megatron	146	Sears	103 108 109		
Emerson	103 104 123 124 131 136 145	Memorex	121				
Emerson TV/VCR . .	158						
Fisher	109 118						

VCRs

Admiral	208 261	General Electric . .	214 216 220	NEC	202 218	Sharp	208 261
Adventura	231	Goldstar	209	Orion	250	Shintom	239
Aiwa	231	Go Video	256 262 263	Panasonic	214 251 259	Signature 2000 . . .	208 214 216 219 231 249
Akai	223 238 241	Hitachi	215 257	Pentax	215	Sony	217 232 237
Audio Dynamics . .	202 218	Instant Replay . . .	214 227	Philco	207 214	Sylvania	207 214 227
Bell & Howell . . .	206 247	J.C. Penny	214 215 218 227	Philips	207 214 227	Symphonic	231
Broksonic	221 226 250 255	JVC	202 224 225 258	Pioneer	210 215	Tashiko	209
Canon	214	Kenwood	202	Portland	246	Tatung	202
Citizen	209	Logik	239	ProScan	216 260	Teac	202 231
Craig	212	LXI	209 231	Quasar	214 259	Teknika	209 234
Curtis Mathes . . .	214 259	Magnavox	207 214 231	RCA	215 216 220 227 240 242 249 260	Toshiba	205 215
Daewoo	244 246 248 254	Marantz	207 218	Realistic	206 208 212 214 231	XR 1000	239
Daytron	236 246	Marta	209	Samsung	220 230 238	Vector Research . .	204 218
DBX	202 218	Memorex	206 212 214 231	Sansui	239	Yamaha	202 218
Emerson	203 209 221 223 226 233 235 243 250	Mitsubishi	204 222 252 264	Sanyo	206 212 247	Zenith	201 224 225 229 237
Fisher	211 212 213 247	Montgomery Ward .	208 214 216 219 231 249	Scott	204 205 233 243		
Funai	231	Multi Tech	239	Sears	206 209 211 212 215		

Programming Codes

Find the codes you need to program your remote. On this page: Cable, Satellite, CD Players, Tape Decks and Audio Tuners and Amplifiers.

Cable Satellite

Allegro 358 362	Kale Vision 335	RCA DSS 373	Unika 348 362
Allegro A/B Switch 361	Macom 314 321	Regency 329	United Satellite . . 344
Gemini 305 331 338	Magnavox 334	Samsung 335	Universal 358 362
General Electric. . . 367	NSC 335 339 368 369 370	Scientific Atlanta . 316 323 336 364	Vid Tech 340
General Instrument 304 305 306 307 308 309 310 318	Oak 311 332 342	Sprucer 313	Video Way 349
Hamlin 302 303 345 365 366	Panasonic 313 320	Standard Comp . . . 335	Viewstar 354 355 372
Jerrold 304 307 308 309 310 318 360 363	Paragon 333	Stargate 379	Zenith 301 353 374
	Philips 347 350 352 354 355	Texscan 339 356 371	Zenith Satellite . . 312 328 330 351 378
	Pioneer 315 343	Tocom 317 318 346	

Video Disc Players

Pioneer 402 403	Sony 404
Sanyo 401	Zenith 401

Audio CD Players

Akai 409 424	Mitsubishi 423 424	RCA 437	Yamaha 448
Crown 410	NAD 425 426 447	Sanyo 438 439	Zenith 460 461 498 501 502
Denon 411	Nakamichi 427 428	Scott 440	
Fisher 412 438	NEC 429	Sharp 441 442	
Goldstar 460	Onkyo 430	Sony 443 444 445	
Harman/Kardon . . 413	Panasonic 431 432	Soundesign 461 498 501 502	
JVC 415	Philips 421 433 434	Sylvania 433	
Kenwood 412 416 417 441	Pioneer 431 435	Teac 446	
Magnavox 421 422 433 434	Quasar 432	Technics 432 459	
	Radio Shack 431 436 439 440 441	Toshiba 447	

Audio Tape Decks

Denon 455	Onkyo 458
Harman/Kardon . . 456	Philips DCC 454
JVC 457	Pioneer 451 478
Kenwood 450	Sony 452

Audio Tuners/Amps

Denon 462 463	Marantz 472 503	Sanyo 481	Teac 494 495
Fisher 464	Onkyo 473	Scott 482	Technics 497
Goldstar 460	Philips 475 476	Sharp 483	Yamaha 496
Harman/Kardon . . 465	Pioneer 477 478 479	Sony 489 490 491 492	Zenith 460 461 498 501 502
JVC 466	Radio Shack 487 488	Soundesign 461 498 501 502	
Kenwood 468 469	Realistic 480		

Zenith Product Codes

A complete list of the button functions on your remote control.

KEY NAME	TV Mode Zenith Code 101	VCR Mode Zenith Code 201	Cable Mode Zenith Code 353	AUX Mode Zenith Code 401
POWER	TV On/Off	VCR On/Off	Cable Box On/Off	AUX TV/Disc
CABLE	Selects Cable	Selects Cable	Selects Cable	Selects Cable
VCR	Selects VCR	Selects VCR	Selects VCR	Selects VCR
AUX	Selects Aux	Selects AUX	Selects Aux	Selects AUX
TV	Selects TV	Selects TV	Selects TV	Selects TV
SURF	Surf On/Off	VCR AM/PM	Cable FC/Fav Ch	AUX Audio
FLASHBK	TV Flashback	VCR Flashback	Cable Flashback	AUX Frame/Time
MUTE	TV Mute	TV Mute	TV Mute	TV Mute
CHANNEL UP	TV Channel Up	VCR Channel Up	Cable Channel Up	AUX Skip >>
CHANNEL DN	TV Channel Dn	VCR Channel Dn	Cable Channel Dn	AUX Skip <<
VOLUME (RIGHT)	TV Volume Up	TV Volume Up	TV Volume Up	TV Volume Up
VOLUME (LEFT)	TV Volume Dn	TV Volume Dn	TV Volume Dn	TV Volume Dn
1	TV Digit 1	VCR Digit 1	Cable Digit 1	AUX Digit 1
2	TV Digit 2	VCR Digit 2	Cable Digit 2	AUX Digit 2
3	TV Digit 3	VCR Digit 3	Cable Digit 3	AUX Digit 3
4	TV Digit 4	VCR Digit 4	Cable Digit 4	AUX Digit 4
5	TV Digit 5	VCR Digit 5	Cable Digit 5	AUX Digit 5
6	TV Digit 6	VCR Digit 6	Cable Digit 6	AUX Digit 6
7	TV Digit 7	VCR Digit 7	Cable Digit 7	AUX Digit 7
8	TV Digit 8	VCR Digit 8	Cable Digit 8	AUX Digit 8
9	TV Digit 9	VCR Digit 9	Cable Digit 9	AUX Digit 9
0	TV Digit 0	VCR Digit 0	Cable Digit 0	AUX Digit 0
ENTER	TV Enter	VCR Enter	Cable Enter	Aux Display
MENU	TV Menu	VCR Menu	Cable Menu	AUX Program
UP ARROW	TV Select Up	VCR Select Up	Cable Up Arrow	AUX Part
DOWN ARROW	TV Select Dn	VCR Select Dn	Cable Dn Arrow	AUX Random
LEFT ARROW	TV Adjust Left	VCR Adjust Left	Cable Left Arrow	AUX x3 FAST <
RIGHT ARROW	TV Adjust Right	VCR Adjust Right	Cable Right Arrow	AUX x3 FAST >
QUIT/ A	TV Seq Sound	VCR Quit	Cable Quit	AUX Clear
B	TV PIP	VCR+	Day Up	AUX Repeat-Side
C	TV PIP Swap	VCR Channel Map	Day Down	AUX Repeat-A-B
CC	TV PIP Freeze	VCR Search	Cable Pg Up	AUX Repeat-Chap
TIMER	TV Closed Captions	VCR Memory	Cable Pg Down	AUX Memory
TV/VCR/SOURCE	TV Timer	VCR Timer	Cable Timer	AUX Still
RECORD	TV Sources	TV Tuner or VCR Tuner	Cable Info	AUX TV/Disc
PAUSE	VCR Record	VCR Record	Cable Buy	AUX Edit
REWIND	VCR Pause	VCR Pause	Cable Guide	AUX Pause
PLAY	VCR Rewind	VCR Rewind	VCR Rewind	AUX Scan <<
STOP	VCR Play	VCR Play	VCR Play	AUX Play
FFWD	VCR Stop	VCR Stop	VCR Stop	AUX Stop/Eject
	VCR Fast Forward	VCR Fast Forward	VCR Fast Forward	AUX Scan >>

References: 124-212-37 and μ P 221-952-02A



Some of the functions, such as PIP, shown above, may not be available on your TV.

A complete list of definitions for words found in this guide.

75 OHM RF CABLE	The wire that comes from an off-air antenna or cable service provider. The end looks like a hex-shaped nut with a wire sticking through the middle. It screws onto the threaded jack on the back of your TV.
300 TO 75 OHM ADAPTER	A small device that connects a two-wire 300 ohm antenna to a 75 ohm RF jack. They are usually about an inch long with two screws on one end and a round opening with a wire sticking out on the other end.
A/V CABLES	Audio/Video cables. Three cables bunched together—right audio (red), left audio (white), and video (yellow). A/V cables are used for stereo playback of videocassettes and for higher quality picture and sound from other A/V devices.
ADD	This function lets you add new channels to list that you'll scroll through when using your remote.
ANTENNA	The physical receiver of television signals sent over the air. A large metal piece of equipment does not always have to be visible for your home to be using an antenna.
AUTO PROGRAM	Auto Program has your Entertainment Machine automatically find all the channels available in your area.
BLOCK	Restrict or censor a channel for a set length of time.
DELETE	This function lets you remove channels that you don't watch from the list you'll scroll through using your remote.
INPUT	Refers to the jack that receives a signal from a TV, VCR or other A/V device.
JACK	A connection on the back of a TV, VCR, or any other A/V device.
MONO SOUND	Mono (monaural) sound is one channel of sound. On more than one speaker, all the speakers play the same audio.
OUTPUT	Refers to the jack that sends a signal out of a VCR, DVD, or other A/V device.
SECOND AUDIO PROGRAMMING/SAP	Second Audio Programming (SAP) is another, separate, audio channel available with some programming. Choosing SAP often refers to listening to audio in another language, such as Spanish or French.
SIGNAL	Picture and sound traveling through cable, or on the air, to your television screen.
STEREO SOUND	Stereo (stereophonic) sound refers to audio that's divided into right and left sides.
TUNER	Device that picks up the signal and turns them into picture and sound.

Troubleshooting

Some quick and easy tips to fixing problems yourself.

SYMPTOMS	SOLUTIONS
Snowy picture and poor sound.	<ul style="list-style-type: none">• Check your antenna connection or location.
Multiple images or 'ghost shadows.'	<ul style="list-style-type: none">• Check your antenna direction and/or location.• Make sure the wire from your antenna to your Entertainment Machine is properly connected.
Interference: Sharp lines across the screen and poor sound.	<p><i>The following may cause image problems or distortion: Electrical appliances, powerful lights, cars, trucks; computers or portable phones; medical equipment</i></p> <ul style="list-style-type: none">• If possible increase the distance between your Entertainment Machine™ and the offending appliance. Or shut one of them off.
Normal picture but no sound.	<ul style="list-style-type: none">• Check volume control.• Make sure the TV is not Muted.• Try another channel. The problem may be the broadcast, not your Entertainment Machine™.• Are the Audio A/V cables properly installed?• Are the wires for external speakers (if you have external speakers) properly installed?
No picture and poor sound.	<ul style="list-style-type: none">• Are you in TV or cable tuning mode and should be in the other?• Make sure output channels on all A/V equipment are on the same channel (3 or 4).• Check that all connections are tight.
No picture and no sound	<ul style="list-style-type: none">• Is the AC power plugged in?• Check that your AC power outlet works. (Test it by plugging in something else or try another plug.)• Make sure your brightness and audio controls are set properly.• Try another channel. The problem may be with the broadcast.
No color, but the sound is O.K.	<ul style="list-style-type: none">• Check the color control in the Video menu.• Try another channel. The problem may be with the broadcast.
Picture has a big black box on it, but the sound is O.K.	<ul style="list-style-type: none">• The CC (closed caption) option may be in Text mode. Select OFF in the Captions/Text menu.
Picture has two horizontal black bars, one on top and one on bottom.	<ul style="list-style-type: none">• Your program is in letterbox. This means that the shape of your TV is a square, but the program is a rectangle. Think of the bars as empty space the program doesn't fill; not picture that's blocked out. Because this format is a direct representation of film as you see it in the movies, you are actually seeing MORE of the program when you see those bars. Trust us.
Remote control doesn't work.	<ul style="list-style-type: none">• Make sure the batteries are fresh and installed properly.• Remove batteries for 30 seconds and replace.
Menu options won't change.	<ul style="list-style-type: none">• Try unplugging the TV, waiting about five minutes, and then plugging it back in and trying again.

Maintenance

Caring for your Entertainment Machine.

Early malfunctions can be prevented. Careful and regular cleaning can extend the amount of time you will have with your new Entertainment Machine. Be sure to turn the power off and pull out the plug before you begin any cleaning.

Screen Cleaning

1. Here's a great way to keep the dust off your screen for a while. Wet a soft cloth in a mixture of lukewarm water and a little fabric softener or dish washing detergent. Wring the cloth until it's almost dry, and then use it to wipe the screen.
2. Make sure the excess water is off the screen, and then let it air-dry before you turn on your Entertainment Machine.

Cabinet Cleaning

1. Use a soft cloth with a mild soap solution to wipe the cabinet (avoid using any cleaner that says "industrial strength" or "will wash the white off of rice" on the label).
2. Rinse the cloth and wipe the cabinet again.
3. Let the cabinet air-dry before turning the Entertainment Machine on.

Wood Cabinets

Use a quality wood cleaner and polish. This will protect the Entertainment Machine from dirt and dust, as well as keep the cabinet looking new.

Extended Absence



If you leave your Entertainment Machine dormant for a long time (such as a vacation), it's a good idea to unplug the power to protect against possible damage from lightning or power surges. If you use an off-air antenna, you may also want to disconnect it from the back of your TV before leaving.



If you unplug your Entertainment Machine, you may have to reset the clock using the Clock Set menu described earlier.

Find what you want quickly.

FEATURE	PAGE
Antenna	6, 8
Amplifier Volume Override	32
Audio Menu	28
Auxiliary Remote Functions	33
Basic Television Operation	15
Batteries	6-9
Button Functions on Remote	13
Cable	7, 9
Captions and Text Menu	19-20
Ch. Add/Del/Surf.	17
Ch. Labels	23
Clock Set	18
EZ Demo	27
EZ Program	12
Front Panel Diagram	14
Glossary	38
Hook-Up Directory	5
Language Menu	21
Maintenance	40
Parental Control	25-26
Programming the Remote	31
Programming Codes	36
Remote Control Diagram	13
Remote Control Auto Find	41
Safety Information	2-4
Setup Menu	16
Source Menu	30
Stereo Amplifier Hookup	11
Super VHS Hookup	10
Timer Setup	22
Troubleshooting	39
VCR	8-10
Video Menu	29
Warranty	43
XDS Display	24
Zenith Product Codes	37

Recommended Video Accessories

Text in here. Type Text in here. Type Text in here. Type Text in here. Type Text in here. Type Text in here.



INDOOR AMPLIFIED ANTENNA

Receive Local programming NOT available on your Satellite system!!! Perfect backup antenna for cable outages. Enhanced quality picture and stereo sound in weak signal areas.

- Amplified VHF/UHF/FM Antenna includes 4 feet of 75 ohm cable for easy hookup.

ATS 775 **ONLY \$34.95** PLUS \$6.95 SHIPPING & HANDLING

TELEVISION WALL MOUNTS

Set up your game room or spare room in style!! Sturdy black wall mounts keep the TV off your furniture and in easy view. All mounts have 90 degree and 10 degree tilt angles.

- ALGW27 fits most 25" to 27" TVs - **ONLY \$59.99**
- ALGW20 fits most 19" and 20" TVs - **ONLY \$49.99**
- ALGW13 fits most 13" Televisions - **ONLY \$39.99**

Available in White, just add "-WH" to part number (e.g. ALGW27-WH)

FOR ALL ORDERS ADD \$6.95
SHIPPING & HANDLING



ZENITH 5 FUNCTION REMOTE

Broken or lost remote? Need a second remote or more functions? Order direct from Zenith!!

- Operates TV, VCR, CD, DVD, & Cable Box
- Operates PIP and Most Screen Menus
- Extended Range & MORE!!!

Orders 1 year or more after product purchase may receive upgraded models. Other Remotes with 3, 4, 5 & 7 Functions Available Upon Request

ZEN 525 **ONLY \$19.99** PLUS \$6.95 SHIPPING & HANDLING



zenith



ORDER TODAY!
CALL OR FAX TOLL-FREE
1.800.255.6790

Fax 1.888.693.6484

email: parts.sales@zenith.com

Use Your Visa or MasterCard to Order

PLEASE ALLOW 3 - 4 WEEKS FOR DELIVERY



Your Zenith Warranty

Direct-View Color TV Welcome into the Zenith family! We believe that you will be pleased with your new Zenith Entertainment Machine. Please read this warranty carefully, it is a "LIMITED WARRANTY" as defined under Federal Law. This warranty gives you specific legal rights, and you may also have other rights that vary from state to state within the U.S.A.

ZENITH RESPONSIBILITY

- Service Labor** During a period of 90 days from effective warranty date, Zenith will provide service labor by a Zenith authorized service center when needed as determined by Zenith, as a result of manufacturing defects.
- Parts** New or remanufactured replacements for factory-defective parts will be supplied by a Zenith authorized service center for one year from effective warranty date (color picture tube — two years). Such replacement parts are warranted for the remaining portion of the original warranty period.
- Home Service** Warranty service for 21" diagonal (U.S.A.) or larger screen size models is provided in the home in most cases. (Some repairs may require the unit to be taken by the servicer to the repair facility and returned, at no additional charge.)
- Not Covered** This warranty covers manufacturing defects and does not cover installation, adjustment of customer controls in the home, installation or repair of home antenna systems, cable converters or cable company-supplied equipment; it also does not cover damage due to misuse, abuse, negligence, acts of God or other causes beyond the control of Zenith. Any alteration of the product after manufacture voids this warranty in its entirety.

THIS WARRANTY IS IN LIEU OF ANY OTHER WARRANTY, EXPRESS OR IMPLIED, INCLUDING WITHOUT LIMITATION, ANY WARRANTY OF MERCHANTABILITY OR FITNESS FOR A PARTICULAR PURPOSE, AND ZENITH SHALL NOT BE LIABLE FOR ANY CONSEQUENTIAL, INDIRECT, OR INCIDENTAL DAMAGES OF ANY KIND, INCLUDING LOST REVENUES OR PROFITS IN CONNECTION WITH THE PRODUCT. SOME STATES DO NOT ALLOW LIMITATIONS ON HOW LONG AN IMPLIED WARRANTY LASTS OR THE EXCLUSION OR LIMITATION OF INCIDENTAL OR CONSEQUENTIAL DAMAGES, SO THE ABOVE LIMITATIONS OR EXCLUSIONS MAY NOT APPLY TO YOU.

OWNER'S RESPONSIBILITY

- Effective Warranty Date** Warranty begins on the date of original consumer purchase. For your convenience, keep the dealer's dated bill of sale or delivery ticket as evidence of the purchase date.
- Operating Guide** Read your Operating Guide carefully so that you will understand the operation of your set and how to adjust the customer controls.
- Carry-In Service** Models under 21" diagonal (U.S.A.) screen size must be taken to a Zenith authorized service center for warranty service and must be picked up by the owner.
- Antenna** Reception problems caused by inadequate home antenna or faulty antenna connections are the owner's responsibility.
- Important** Product Registration—Please fill out and mail your Product Registration Card. It is imperative that Zenith know how to reach you promptly if we should discover a safety problem that could affect you.
- Warranty Service** For warranty service information, contact any Zenith authorized service center. Parts and service labor that are Zenith's responsibility (see above) will be provided without charge. Other service is at the owner's expense. If you have any problem in obtaining satisfactory warranty service, call or write the Zenith Response Center. You must provide the model number, serial number and date of purchase or date of original installation. Before you ask for warranty service, read "Maintenance and Troubleshooting" in your operating guide. You might avoid a service call.

ZENITH ELECTRONICS CORPORATION Zenith Response Center

201 James Record Rd., Building 3,
Huntsville, AL 35824
Telephone (256) 772-1515
Mon-Fri, 7:00 a.m.-8:00 p.m. CST
Sat. 8:00 a.m.-5:00 p.m. CST
www.zenith.com

ZENITH CONSUMER SERVICES FACTORY OWNED SERVICE CENTERS

**801 E. Roosevelt Rd
Lombard, IL 60148
(630)705-2830**

Home & Carry-in Service
Television/VCR
Parts and Accessories
PTV/Camcorders

**201 James Record Rd.
Building 4
Huntsville, AL 35824
(256) 774-4025**

Service Hours:
M-F 8-6, Sat 9-2
Will accept UPS Shipments

Additional Zenith Picture Tube Protection Plan Available

Zenith offers you the opportunity to obtain additional long-term protection against failure of the picture tube in your new Entertainment Machine. Our Picture Tube Protection Plan enables you to avoid any unexpected picture tube repair expenses and keep your Entertainment Machine in top condition. It guarantees you a genuine Zenith replacement picture tube and service from a Zenith authorized service center.



Be sure to send in the Product Registration Card. We will send you an application for the Protection Plan near the expiration of the two-year manufacturer's warranty on the picture tube. For additional information call (256) 774-4088.